

# OWNER'S MANUAL SIDE BY SIDE REFRIGERATOR

Please read this manual carefully before operating your set and retain it for future reference.

# MANUAL DE USUARIO REFRIGERADOR DE DOS PUERTAS

Lea detenidamente este manual antes de empezar a utilizar el refrigerador y guárdelo como referencia para el futuro.

Model Name/Nombre de Modelo\*\*=color number/número de color  
LSC27925\*\*

# WARRANTY

Visit our web site <http://www.lg.com>

LG Electronics

## LIMITED WARRANTY United States of America

LG Electronics will repair or at its option replace, without charge, your product which proves to be defective in material or workmanship under normal use during the warranty period listed below from the date of original purchase.

This warranty is good only to the original purchaser of the product during the warranty period as long as it is in the U.S. including Alaska, Hawaii, and U.S. Territories.

### LG Refrigerator / Freezer Warranty Period

Product	Parts	Labor
Refrigerator / Freezer	1 year	1 year [In-Home Service (Except Model GR-051)]
Sealed System (Compressor, Condenser, Evaporator)	7 years	1 year [In-Home Service (Except Model GR-051)]

No other express warranty is applicable to this product. THE DURATION OF ANY IMPLIED WARRANTIES, INCLUDING THE IMPLIED WARRANTY OF MERCHANTABILITY, IS LIMITED TO THE DURATION OF THE EXPRESS WARRANTY HEREIN. LG ELECTRONICS SHALL NOT BE LIABLE FOR THE LOSS OF USE OF THE PRODUCT, INCONVENIENCE OR ANY OTHER DAMAGES, DIRECT OR CONSEQUENTIAL, ARISING OUT OF THE USE OF OR INABILITY TO USE THIS PRODUCT OR FOR ANY BREACH OF ANY EXPRESS OR IMPLIED WARRANTY, INCLUDING THE IMPLIED WARRANTY OF MERCHANTABILITY APPLICABLE TO THIS PRODUCT.

Some States do not allow the exclusion or limitation of incidental or consequential damages or limitations on how long an implied warranty lasts; so these limitations or exclusions may not apply to you. This warranty gives you specific legal rights and you may also have other rights which vary from state to state.

### THE ABOVE WARRANTY DOES NOT APPLY TO:

1. Service trips to your home to deliver and pickup, install, instruct, or replace house fuses or correct house wiring or plumbing, or correction of unauthorized repairs.
2. Damage to the product caused by accident, pests, fire, floods, or acts of God.
3. Repairs when your LG product is used in other than normal, single-family household use.
4. Damage resulting from accident, alteration, misuse, abuse, or improper installation.
5. Damages caused during and/or after delivery.
6. Display, discount, or refurbished units purchased with scratches, dents, or defects.

Proof of purchase is required and must be provided to LG in order to validate warranty.

**Therefore, these costs are paid by the consumer.**

If the product is installed outside the normal service area, any cost of transportation involved in the repair of the product, or the replacement of defective parts, shall be borne by the owner.

### CUSTOMER ASSISTANCE NUMBERS:

<b>To obtain Warranty Coverage:</b>	<b>Retain your Bill of Sale to prove date of purchase.</b> A Copy of your Sales Receipt must be submitted at the time warranty service is provided.
<b>To obtain Product or Customer:</b>	<b>Call 1-800-243-0000</b> (24 hrs a day, 7 days per week, 365 days per year).
<b>Service Assistance:</b>	Press the appropriate menu option, and have your product type (Refrigerator), model number, serial number, and ZIP/Postal Code ready.
<b>To obtain the nearest Authorized Service Center:</b>	<b>Call 1-800-243-0000</b> (24 hrs a day, 7 days per week, 365 days per year) Press the appropriate option, and have your product type (Refrigerator), model number, serial number, and ZIP/Postal Code ready.

# TABLE OF CONTENTS

<b>Warranty (USA)</b>	<b>1-2</b>	Food Storage Guide	15
		Storing Frozen Food	15
		Water and Ice Dispenser	16
<b>English Version</b>	<b>3-25</b>	Ice Storage Bin	16
		Ice maker Cover	16
		Door and Rack Support	16
<b>Spanish Version</b>	<b>26-49</b>	Snack Pan	16
		Crisper and Crisper Cover	17
		Humidity Controls	17
<b>Important Safety Instructions</b>	<b>4-5</b>	Refrigerator Shelves	17
Requirements for Ground Connection	5	Freezer Shelf	17
<b>Refrigerator Installation</b>	<b>6-11</b>	<b>Filter</b>	<b>18-19</b>
Unpacking your Refrigerator	6	Water Filter	18
Installation	6	Performance Data Sheet	19
Base Grille Installation	6		
Handle Removal	6-7	<b>Care and Cleaning</b>	<b>20-21</b>
Handle Installation	7	General Cleaning Tips	20
Removing and Replacing		Outside	20
Refrigerator Doors	7-8	Inside Walls	20
Door Alignment	8	Door Liners & Gaskets	20
Connecting the Water Line	9-11	Plastic Parts (Covers and Panel)	20
		Back Cover	20
<b>Refrigerator Features</b>	<b>12</b>	Light (LED) Replacement	20
		Power Interruptions	20-21
<b>Using your Refrigerator</b>	<b>13-17</b>	When you go on Vacation	21
Ensuring Proper Air Circulation	13	When you Move	21
Prior to Use	13	When you should set the Ice maker	
Control Panel Features	13	Power Switch to off	21
Refrigerator and Freezer Controls	13-14	Normal Sounds you May Hear	21
Adjusting Control Settings	14		
Ice maker Operation	14-15	<b>Troubleshooting Guide</b>	<b>22-25</b>

# IMPORTANT SAFETY INSTRUCTIONS

## SAFETY MESSAGES

This manual contains several important safety notices. Always read and obey all of the following safety messages.



This is the safety alert symbol. This symbol is a warning to potential dangers that could cause death, injury or damage to you, others or the product. All safety messages will follow after this warning symbol and the word "DANGER", "CAUTION" or "WARNING". These words mean:

### DANGER

You may be killed or suffer fatal damage if you do not follow instructions.

### WARNING

You may be killed or seriously injured if you do not follow instructions.

### CAUTION

Indicates a potentially hazardous situation which, if not avoided, may result in minor injury or damage to the product.

All safety messages inform you of potential danger, advise you on how to reduce the risk of injury and tell you what can occur if the instructions are not followed.

## WARNING

**To reduce the risk of fire, electrical shock or personal injury, the following precaution measures should be followed:**

- NEVER disconnect the refrigerator by pulling the power cord, always grip the plug firmly and disconnect it directly from the outlet.
- Immediately repair or replace all faulty or damaged service cables. Do not use cords that have cracks or abrasion damage on the length of the cord or on the plug.
- When moving your refrigerator, take care not to roll over the electrical cord.
- **DO NOT** store or use gasoline or other combustible liquids or vapors in proximity with this or any other electrical appliance.
- **DO NOT** permit children to climb, stand or swing from the doors or shelves of the refrigerator. This can cause serious injury to them and damage to the product.
- Keep your fingers away from areas in which they can become caught, such as the doors, hinges and cabinets. Be careful closing the doors when children are near.
- Unplug the refrigerator before cleaning or repairing. **NOTE:** We strongly recommend that any repair services be performed by a qualified professional.
- Before replacing a burned-out light bulb, unplug the refrigerator or shut down the circuit breaker to avoid contact with a live wire (the bulb could break while being replaced). **NOTE:** Setting the control to the OFF position does not disconnect the power from the light bulb circuit.
- Do not keep bottles in the freezer compartment, they could explode after freezing and cause damage.
- For your safety, this product should be properly grounded. Have a qualified professional check the electrical circuit and outlet to ensure a proper ground connection.
- Read all instructions before utilizing the product. Utilize this product only as explicitly expressed in this guide.
- Once the refrigerator is operating, avoid touching cold surfaces of the freezer with damp or wet hands; the skin could become adhered to these surfaces.
- In refrigerators with an automatic ice dispenser, avoid contact with moving parts of the ejector mechanism or with the heating mechanism that discharges the cubes. **DO NOT** place your fingers or hands in the ice dispenser mechanism while the refrigerator is connected.
- **DO NOT** refreeze foods which have already thawed. The Department of Agriculture of the United States, in your Bulletin of Home and Gardens No. 69 establishes that: "...You can refreeze food that has thawed if they contain ice crystals or are cold and below 40 °F (4 °C)".  
"...Ground beef, perishable food or seafood that is discolored or has an unpleasant odor should not be frozen or consumed. Consumption of melted ice cream should also be avoided. If the odor or color of food is questionable, discard it. The food may be dangerous to consume".  
"Partial thawing or refreezing reduces the quality of the food, especially fruit, vegetables and prepared meals. The quality of red meat is less affected than other foods. Use refrozen products as soon as possible in order to maintain their quality".

**SAVE THESE INSTRUCTIONS**

## ⚠ CAUTION

This appliance is not intended for use by children, persons with physical or mental disabilities, persons with reduced sensory or mental capacity, or persons with lack of experience or know-how, unless they have supervision or instruction in relation to the use of the appliance by the person responsible for their safety. Children should be supervised to assure that they do not play with the appliance.

## ⚠ DANGER: CHILDREN MAY BECOME TRAPPED

Children becoming trapped or suffocated is not a problem of the past. Discarded and abandoned refrigerators are a hazard, even if they remain there "for just a few days". If you would like to dispose of your old refrigerator, please follow the instructions below to prevent any accidents.

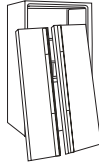

### BEFORE DISPOSING YOUR REFRIGERATOR OR FREEZER WHEN NO LONGER IN USE:

- Remove the doors.
- Leave the shelves in place so that children cannot easily become stuck in them.

## CFC DISPOSAL

Your old refrigerator may have a cooling system that uses CFC's (chlorofluorocarbons). CFC affects the stratospheric layer of the ozone.

If you decide to throw out your old refrigerator, ensure that CFC contaminants are properly disposed of by a qualified professional. If you intentionally remove the CFC refrigerant, you could be subject to fines or prison in accordance with environmental legislation in effect.

## REQUIREMENTS FOR GROUND CONNECTION

**IMPORTANT:** Attentively read the following.

### TO CONNECT ELECTRICITY

#### ⚠ WARNING

##### ELECTRICAL SHOCK HAZARD

**FOR YOUR PERSONAL SAFETY**, this appliance must be properly grounded. Have a qualified electrician check your wall outlet to ensure that the plug is grounded properly.

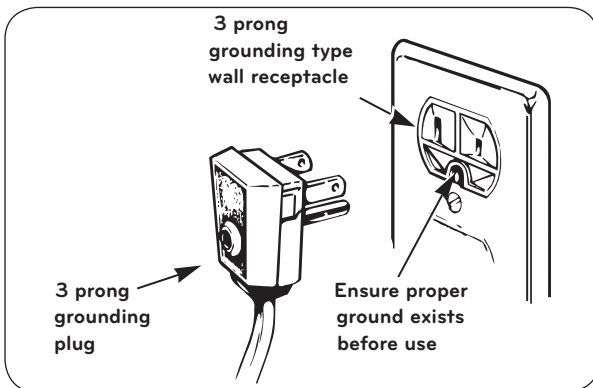

### RECOMMENDED GROUNDING METHOD

Your refrigerator must always be plugged to its own outlet which is adequately grounded. The energy current should only be 115 V, 60 Hz, A.C. and fused at 15 or 20 A. This provides the best performance and prevents an overload which could cause a fire from the overheating of the cables. It is recommended that a separate circuit be used for this appliance, as well as a receptacle that cannot be disconnected with a switch.

Do not use an extension cable.

It is your responsibility and obligation to replace two-prong outlets with that of an adequately grounded three-prong outlet.

**Do not, under any circumstance, cut or extract the third prong from the plug.**

**NOTE:** Before installation, cleaning or replacing light bulbs, you must disconnect the appliance from the power source. When finished, plug the appliance back in and adjust the thermostat to the desired position.

### USE OF EXTENSION CABLES

**We do not recommend the use of extension cables.** However, if you still choose to utilize an extension cable, it is absolutely necessary that it is listed in the UL (in the United States) or CSA (in Canada), that it supports three-pronged plugs and that the electrical current support a minimum of 15 A and 120 V.

The use of an extension cable will increase the amount of space needed behind the refrigerator.

#### ⚠ WARNING

##### REPLACING ELECTRICAL CABLE

If the power cord is damaged, it must be replaced by our service center or qualified LG technician to avoid any risk.

# REFRIGERATOR INSTALLATION

## ⚠ WARNING

### EXCESSIVE WEIGHT HAZARD

Use the assistance of two or more persons to move or install the refrigerator. Not following these instructions may cause injury to the back and other parts of the body.

cooling ability may be adversely affected.

**NOTE:** For proper air circulation, and best cooling and energy consumption results, maintain a minimum distance of 2 inches (5,08 cm) from adjacent items and surfaces.

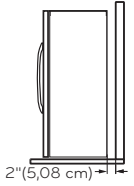

## UNPACKING YOUR REFRIGERATOR

Before installing your refrigerator, remove any tape or temporary stickers. Do not remove any stickers that feature warnings, the model serial number or the technical label of the product located on the back of the refrigerator.

To remove adhesive tape residue, rub it well with your fingers and a little liquid detergent. Clean with warm water and let dry.

Do not use sharp instruments, rubbing alcohol, flammable liquids or abrasive cleaning products to remove the adhesive tape or glue. These products can damage the surface of your refrigerator. For more information, see the section on "Important Safety Instructions".

The shelves come already installed in their factory position. Remove the shelves and replace them according to your spacing needs.

## ⚠ WARNING

### WHEN MOVING YOUR REFRIGERATOR

Your refrigerator is extremely heavy. Make sure you protect the floor when moving your refrigerator for cleaning or servicing. Always pull your refrigerator straight out when moving it. Do not shift from side to side or "walk" the refrigerator when attempting to move it as this can cause damage to the floor.

## ⚠ WARNING

### EXPLOSION HAZARD



Keep all flammable materials and vapors (such as gasoline) away from the refrigerator. Not following these instructions may cause death, explosion or fire.

## INSTALLATION

1. Avoid placing the unit near heat sources, direct sunlight or humidity.
2. To minimize noise and vibration, the refrigerator **MUST** be installed on a solidly constructed floor.
3. Carpeting and soft tile surfaces are not recommended.
4. **NEVER** install the refrigerator on a platform or a weakly supported structure.
5. Install this appliance in an area where the temperature is between 41 °F (5 °C) and 110 °F (43 °C). If the temperature around the appliance is too low or high,

## ⚠ WARNING

Be careful when you work with the hinge, base grille, stopper, etc. You may be injured. Do not put hands or metal sticks into air vents, base grille or bottom of the refrigerator. You may be injured or receive an electrical shock.

## BASE GRILLE INSTALLATION

**To install or replace base grille:**

1. Remove the 2 screws from the bottom front part of refrigerator.
2. Place base grille into position and insert and tighten screws.

**To remove the base grille:**

1. Open the doors (Refrigerator and Freezer).
2. Once doors are open, remove screws from base grille and remove.
3. Reattach screws to the base of refrigerator.

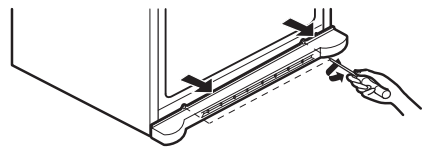

## HANDLE REMOVAL

You may have to remove the door handles to move the refrigerator through a narrow opening. See instructions below.

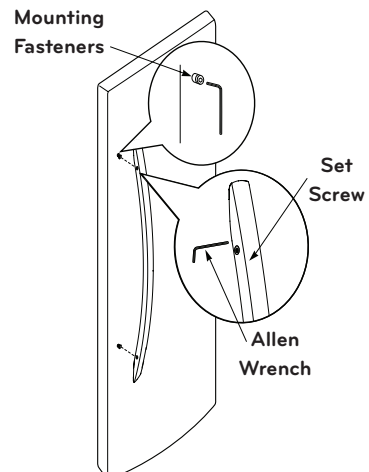

# REFRIGERATOR INSTALLATION

**NOTE:** To avoid damaging door surfaces when moving the refrigerator through narrow openings, it is **ALWAYS** recommended to remove the doors as instructed in the next two pages.

- Loosen the set screws with a 3/32" (2,38 mm) Allen wrench and remove the handle.

**NOTE:** If the handle mounting fasteners need to be tightened or moved, use a 1/4" (6,35 mm) Allen wrench.

## HANDLE INSTALLATION

Place the handle on the door by adjusting handle footprints to fit mounting fasteners and tighten the set screws with a 3/32" (2,38 mm) Allen wrench .

**NOTE:** If the handle mounting fasteners need to be tightened or removed use a 1/4" (6,35 mm) Allen wrench.

### ⚠ WARNING

#### ELECTRIC SHOCK HAZARD

- Disconnect electrical supply to the refrigerator before installing. Failure to do so could result in death or serious injury.
- Do not put hands, feet or other objects into the air vents, base grille, or bottom of the refrigerator. You may be injured or receive an electrical shock.
- Be careful when you work with the hinge, base grille and stopper. You may be injured. Before removing the doors, remove the base grille.

## REMOVING AND REPLACING REFRIGERATOR DOORS

Before removing the doors, remove the base grille. See "Base Grille Installation" for reference.

### To remove the right (refrigerator) door:

1. Open the door. Remove the top hinge cover screw (1).
2. Use a flat blade screwdriver to pry back the hooks (not shown) of the hinge cover (2) from the top of the refrigerator cabinet. Lift up the cover.
3. Rotate the hinge lever (3) clockwise. Lift the top hinge (4) free of the hinge lever latch (5).

**NOTE:** Regardless of hinge lever type, removal process is the same.

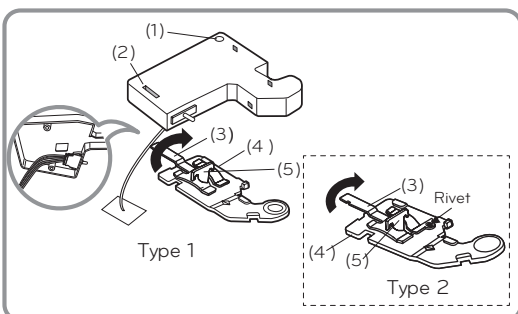

4. Lift the door from the lower hinge pin.
5. Place the door, inside facing up, on a non scratching surface.

**⚠ CAUTION:** When lifting the hinge free of the latch, be careful that the door does not fall forward.

### Removing the left (freezer) door with water line connection:

Pull up the water feed tube while pressing the area (Figure 1) as shown in the figure below.

**NOTE:** If a tube end is deformed or abraded, trim the part away. Disconnecting the tube under the door causes about 0,13 gallons (0,5 liters) water to flow out. Put a large container at end of tube to prevent water from draining onto the floor.

1. Open the door. Remove the top hinge cover screw (1).
2. Use a flat blade screwdriver to pry back the hooks (not shown) of the hinge cover (2) from the top of the refrigerator cabinet (2). Lift up the cover.
3. Disconnect all the wire harnesses (3).
4. Remove the grounding screw (4).
5. Rotate hinge lever (5) counterclockwise. Lift the top hinge (6) free of the hinge lever latch (7).

**NOTE:** Regardless of hinge lever type, removal process is the same.

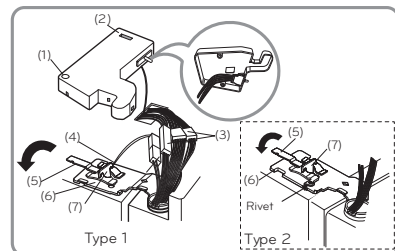
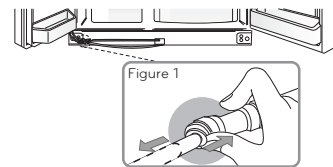

**⚠ CAUTION:** When lifting the hinge free of the latch, be careful that the door does not fall forward.

6. Lift the door from the lower hinge pin being careful to pull the water lines through the lower hinge pin.
7. Place the door, inside facing up, on a non scratching surface.

### Reinstalling the right (refrigerator) door:

1. Place the door onto the lower hinge pin.
2. Fit top hinge (4) over hinge lever latch (5) into place. Rotate lever (3) counterclockwise to secure hinge.

**NOTE:** Regardless of hinge lever type, reinstallation process is the same.

# REFRIGERATOR INSTALLATION

- Hook tab on switch side of corner under edge of wire opening in cabinet top. Position cover (2) into place. Insert and tighten cover screw (1).

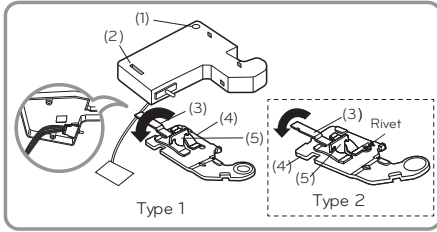

## Reinstalling the left (freezer) door:

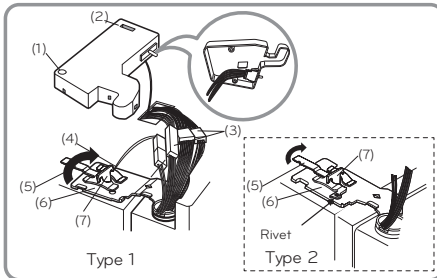

- Feed the water tubes through the lower hinge pin and place the door onto the lower hinge pin.
- Fit top hinge (6) over hinge lever latch (7) and into place. Rotate lever (5) clockwise to secure hinge.

**NOTE:** Regardless of hinge lever type, reinstallation process is the same.

- Install the grounding screw (4) and connect all the wire harnesses (3).
- Hook tab on door switch side of cover (2) under edge of wire opening in cabinet top. Position cover into place. Insert and tighten cover screw (1).
- Reconnect the water tubes by inserting the tubes into the connectors.

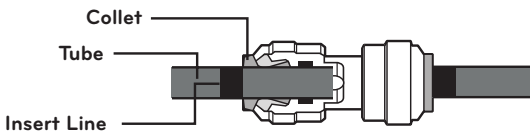

## DOOR ALIGNMENT

Remove the base grille before adjusting the doors. See "Base Grille Installation" for reference. Two methods of door alignment are available based on the amount of adjustment needed and installation requirements.

### Type 1

**Adjusting tool: Flat blade screwdriver.** If the freezer compartment door is lower than the refrigerator compartment door, level them by inserting a flat blade screwdriver into the groove of the left leveling leg and rotating it clockwise.

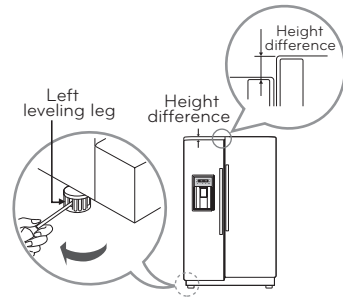

If the freezer compartment door is higher than the refrigerator compartment door, level them by inserting a flat blade screwdriver into the groove of the right leveling leg and rotating it clockwise.

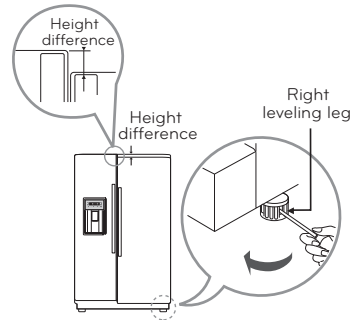

### Type 2

**Adjusting tools: 5/16" (8 mm) wrench and 3/4" (19 mm) wrench.**

Using a 3/4" (19 mm) wrench, turn the keeper nut clockwise to loosen the keeper nut. Using a 5/16" (8 mm) wrench, turn the adjustment hinge pin clockwise or counterclockwise to level the refrigerator and freezer door. After setting level door, turn the keeper nut counterclockwise to tighten.

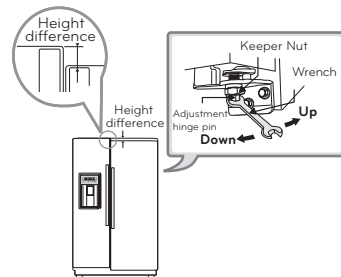

**CAUTION:** Do not over tight the door adjustment screw. The hinge pin can be pulled out. (Adjustable range of height is a maximum of 1/2" (1,27 cm)).

## AFTER LEVELING THE DOOR HEIGHT

Confirm all legs are in contact with the floor.



# REFRIGERATOR INSTALLATION

## CONNECTING THE WATER LINE

**NOTE:** Water line installation is needed when the Automatic Ice maker and/or Water Dispenser features are available on your product.

## BEFORE YOU BEGIN

This water line installation is not warranted by the refrigerator or ice maker manufacturer or seller. Follow these instructions carefully to minimize the risk of expensive water damage. Water hammer (water banging in the pipes) in house plumbing can cause damage to refrigerator parts and lead to water leakage or flooding. Call a qualified plumber to correct water hammer before installing the water supply line to the refrigerator.

To prevent burns and product damage, do not hook up the water line to the hot water line.

If you use your refrigerator before connecting the water line, make sure the ice maker power switch is in the **OFF (O)** position. Do not install the ice maker tubing in areas where temperatures fall below freezing.

When using any electrical device (such as a power drill) during installation, be sure the device is double insulated or grounded in a manner to prevent the hazard of electric shock, or is battery-powered. All installations **MUST** be in accordance with local plumbing code requirements.

**NOTE:** Wear eye protection.

- If a reverse osmosis water filtration system is connected to your cold water supply, the water line installation is not warranted by the refrigerator or ice maker manufacturer or seller. Follow next instruction carefully to minimize the risk of expensive water damage.
- If a reverse osmosis water filtration system is connected to your cold water supply, the water pressure to the reverse osmosis system needs to be a minimum of 40 to 60 PSI (2,8 kg•f/cm<sup>2</sup> ~ 4,2 kg•f/cm<sup>2</sup>, less than 2~3 sec to fill a cup of 7 oz. capacity).

If the water pressure from the reverse osmosis system is less than 21 PSI (1,5 kg•f/cm<sup>2</sup>, more than 4 sec to fill a cup of 7 oz. capacity):

- Check to see whether the sediment filter in the reverse osmosis system is blocked. Replace the filter if necessary.
- Allow the storage tank on the reverse osmosis system to refill after heavy usage.
- If the issue about water pressure from reverse osmosis remains, call a licensed, qualified plumber.

## WHAT YOU WILL NEED

- **Copper Tubing**, 1/4" (6,35 mm) outer diameter to connect the refrigerator to the water supply. Be sure both ends of the tubing are cut square.



To determine how much tubing you need, measure the distance from the water valve on the back of the refrigerator to the water supply pipe. Then add 8 feet

(2,4 m). Be sure there is sufficient extra tubing (about 8 feet [2,4 m] coiled into 3 turns of about 10" [25 cm] diameter) to allow the refrigerator to move out from the wall after installation.

Be sure that the kit you select allows at least 8 feet (2,4 m) as described above.

- **A cold water supply.** The water pressure **MUST** be between 20 and 120 PSI (1,4 bar and 8,2 bar) on models without a water filter and between 40 and 120 PSI (2,8 bar and 8,2 bar) on models with a water filter.

- **Power drill.**

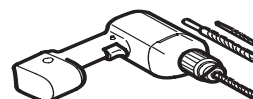

- **1/2" (12,7 mm) or Adjustable Wrench.**

- **Flat head and Phillips screwdrivers.**

- **Two 1/4" (6,35 mm) outer diameter compression nuts and 2 ferrules (sleeves)** to connect the copper tubing to the shutoff valve and the refrigerator water valve.

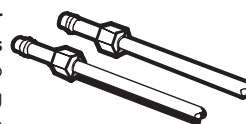

If your existing copper water line has a flared fitting at the end, you will need an adapter (available at plumbing supply stores) to connect the water line to the refrigerator **OR** you can cut off the flared fitting with a tube cutter and then use a compression fitting.

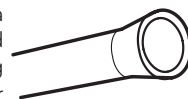

- **Shutoff valve to connect to the cold water line.** The shutoff valve should have a water inlet with a minimum inside diameter of 5/32" (3,96 mm) at the point of connection to the COLD WATER LINE. Saddle-type shutoff valves are included in many water supply kits. Before purchasing, make sure a saddle-type valve complies with your local plumbing codes.

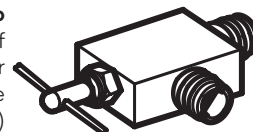

## INSTALLATION INSTRUCTIONS

**⚠ WARNING:** Connect to potable water supply only.

### 1. SHUTOFF THE MAIN WATER SUPPLY

Turn on the nearest faucet to relieve the pressure on the line.

### 2. CHOOSE THE VALVE LOCATION

Choose a location for the valve that is easily accessible. It is best to connect into the side of a vertical water pipe. When it is necessary to connect into a horizontal water pipe, make the connection to the top or side, rather than at the bottom, to avoid drawing off any sediment from the water pipe.



# REFRIGERATOR INSTALLATION

## 3. DRILL THE HOLE FOR THE VALVE

Drill a 1/4" (6,35 mm) hole in the water pipe using a sharp bit. Remove any burrs resulting from drilling the hole in the pipe. Take care not to allow water to drain into the drill. Failure to drill a 1/4" (6,35 mm) hole may result in reduced ice production or smaller cubes.

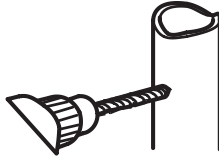

**NOTE:** Licensed plumbers MUST use only cooper tubing NDA tubing #49595 or 49499 or Cross Link Polyethylene (PEX) tubing.

## 4. FASTEN THE SHUTOFF VALVE

Fasten the shutoff valve to the cold water pipe with the pipe clamp.

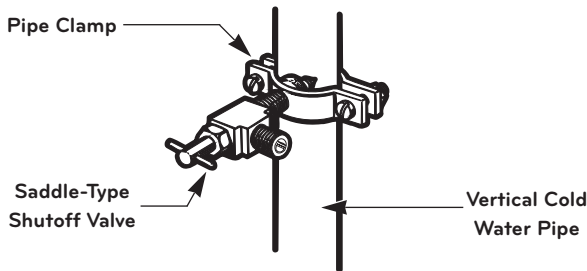

**NOTE:** Commonwealth of Massachusetts Plumbing Codes 248CMR shall be adhered to. Saddle valves are illegal and use is not permitted in Massachusetts. Consult with your licensed plumber.

## 5. TIGHTEN THE PIPE CLAMP

Tighten the clamp screws until the sealing washer begins to swell.

**NOTE:** Do not overtighten or you may crush the tubing.

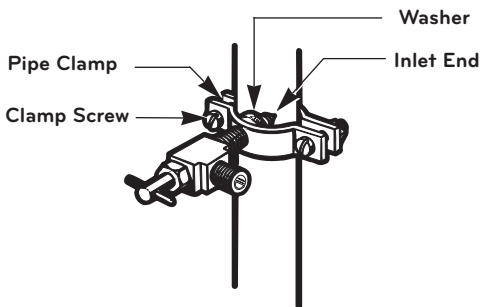

## 6. ROUTE THE TUBING

Route the tubing between the cold water line and the refrigerator. Route the tubing through a hole drilled in the wall or floor (behind the refrigerator or adjacent base cabinet) as close to the wall as possible.

**NOTE:** Be sure there is sufficient extra tubing [about 8 feet (2,4 m) coiled into 3 turns of about 10" (25 cm) diameter] to allow the refrigerator to move out from the wall after installation.

## 7. CONNECT THE TUBING TO THE VALVE

Place the compression nut and ferrule (sleeve) for copper tubing onto the end of the tubing and connect it to the shutoff valve. Make sure the tubing is fully inserted into the valve. Tighten the compression nut securely.

**NOTE:** Commonwealth of Massachusetts Plumbing Codes 248CMR shall be adhered to. Saddle valves are illegal and use is not permitted in Massachusetts. Consult with your licensed plumber.

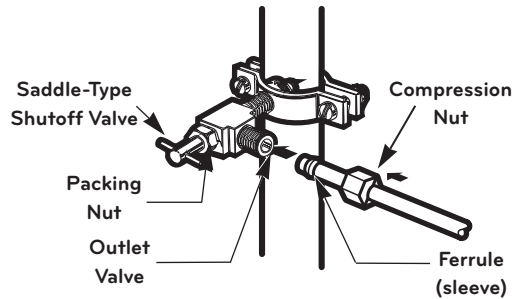

## 8. FLUSH OUT THE TUBING

Turn the main water supply on and flush out the tubing until the water is clear. Shut the water off at the water valve after about one quart (1 L) of water has been flushed through the tubing.

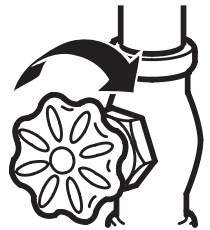

## 9. CONNECT THE TUBING TO THE REFRIGERATOR

### NOTES:

- Before making the connection to the refrigerator, be sure the refrigerator power cord is not plugged into the wall outlet.
  - If your refrigerator does not have a water filter, we recommend installing one. If your water supply has sand or particles that could clog the screen of the refrigerator's water valve, install the filter in the water line near the refrigerator.
  - Do not use old hoses; only use new hoses provided by the manufacturer.
1. Remove the plastic flexible cap from the refrigerator connection.
  2. Place the compression nut and ferrule (sleeve) onto the end of the tubing. (See figure 1).
  3. Insert the end of the tubing into the connection as far as possible. While holding the tubing, tighten the fitting.

**⚠ CAUTION:** Check to make sure that leaks are not occurring in the water line.

# REFRIGERATOR INSTALLATION

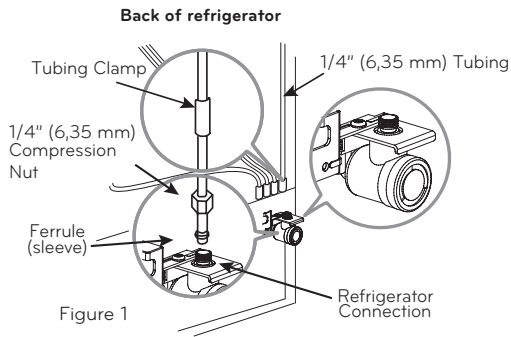

Fasten the tubing into the tubing clamp attached to the back of the refrigerator. First, loosen the screw fastening the clamp. Next, insert the tubing in the groove. Finally, re-fasten the screw.

## 10. PLUG IN THE REFRIGERATOR

Arrange the coil of tubing so that it does not vibrate against the back of the refrigerator or against the wall. Push the refrigerator back to the wall.

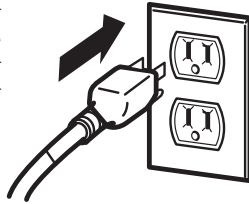

## 11. START THE ICE MAKER

Set the ice maker power switch to the **ON (I)** position. The ice maker will not begin to operate until it reaches its operating temperature of 15 °F (-9 °C) or below. It will then begin operation automatically if the ice maker power switch is in the **ON (I)** position.

## REFRIGERATOR FEATURES

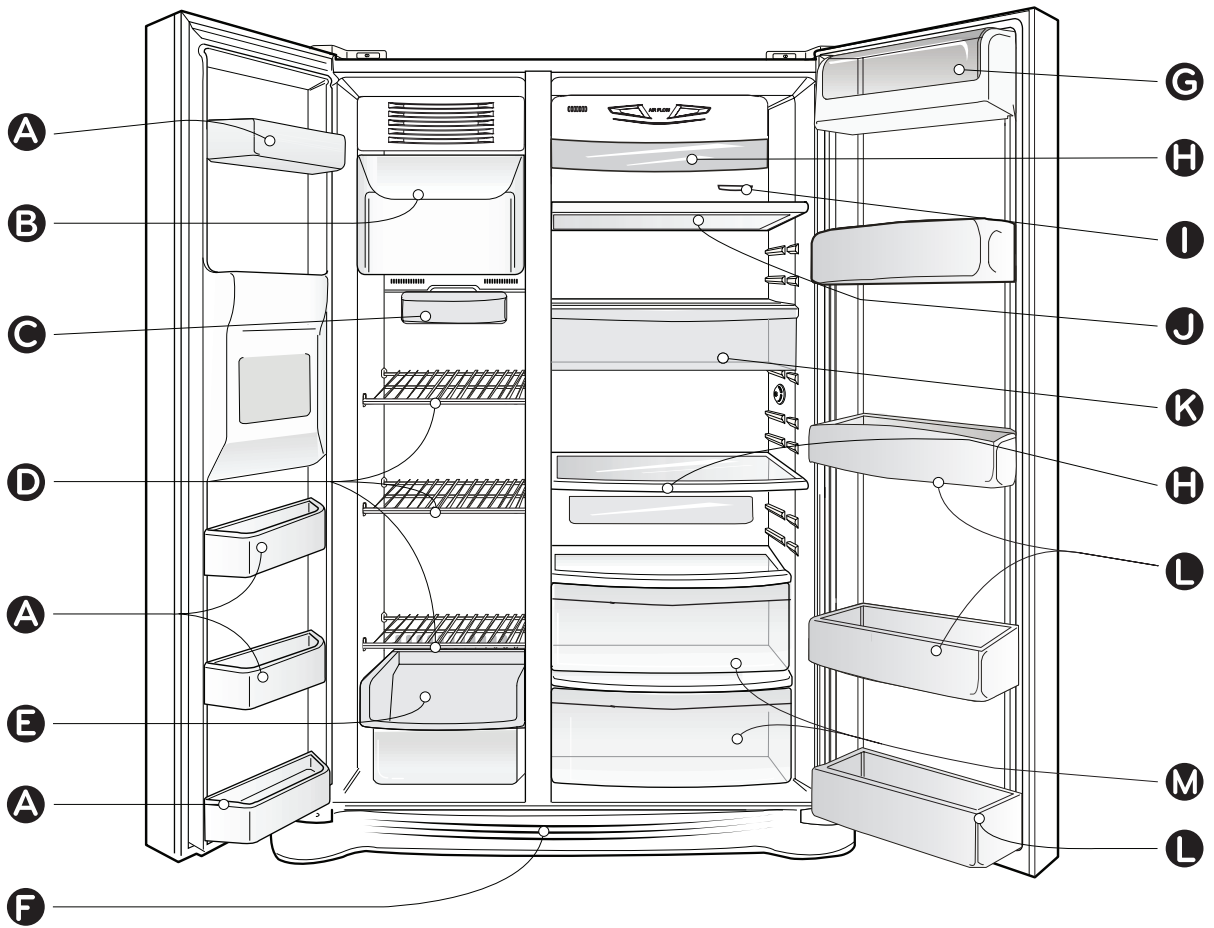

Use this page to become more familiar with the parts and features.

**NOTE:** This guide covers several different models. The refrigerator you have purchased may have some or all of the items listed below. The locations of the features shown below may not match your model.

- |   |  |
|---|--|
| <b>A</b> Freezer Door Rack  | <b>H</b> Refrigerator Lamp (LED)                           |
| <b>B</b> Automatic Ice maker<br>The ice is produced in the ice maker and sent to the dispenser. | <b>I</b> Water Filter                                      |
| <b>C</b> Freezer Lamp (LED)   | <b>J</b> Refrigerator Shelf                                |
| <b>D</b> Freezer Shelf  | <b>K</b> Snack Pan *<br>For storage of meat or fresh food. |
| <b>E</b> Drawer   | <b>L</b> Refrigerator Door Rack                            |
| <b>F</b> Base Grille  | <b>M</b> Vegetable Drawer                                  |
| <b>G</b> Dairy Corner<br>For storage of dairy products such as butter and cheese.               |  |

\* In some models

# USING YOUR REFRIGERATOR

## ENSURING PROPER AIR CIRCULATION

In order to ensure proper temperatures, air **MUST** flow between the refrigerator and freezer sections.

- Cool air enters the freezer through the vents located at the top of the compartment and exits through the vents located behind the freezer drawers.
- Cool air from the freezer section enters the fresh food section through vents located at the top of the compartment. The air moves down throughout the compartment and exits through the vents located behind the crisper drawers.

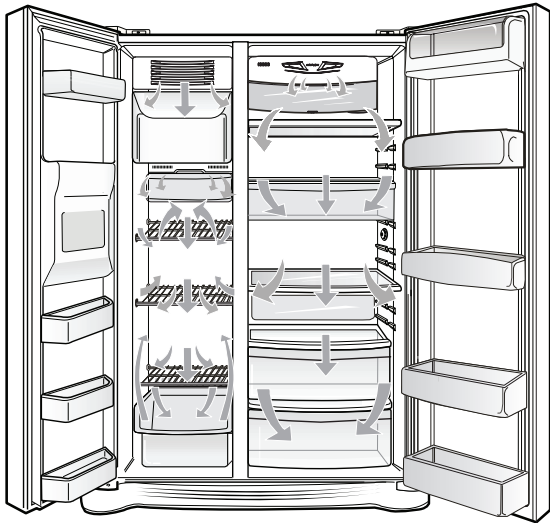

- **Do not block any of these vents** with food packages. If the vents are blocked, airflow will be interrupted and temperature and moisture problems may occur.

**IMPORTANT:** Because air circulates between both sections, any odors formed in one section will transfer to the other.

You **MUST** thoroughly clean both sections to eliminate odors. To prevent odor transfer and dried out food, wrap or cover foods tightly. (See the **"Food Storage Guide"** section for details.)

**NOTE:** If you close the refrigerator door, you may see the freezer door open and close again due to pressure from internal air flow.

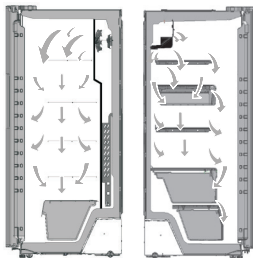

## PRIOR TO USE

1. Clean your refrigerator thoroughly and wipe off dust accumulated during shipping.
2. Install accessories such as ice cube bin, drawers, shelves, etc., in their proper places. They are packed together to prevent possible damage during shipment.
3. Let your refrigerator run for at least 2 or 3 hours before putting food in it. Check the flow of cold air in the

freezer compartment to ensure proper cooling. Your refrigerator is now ready for use.

## CONTROL PANEL FEATURES

Press the button for the desired function to review and select other settings.



## REFRIGERATOR AND FREEZER CONTROLS

Initially set the refrigerator and freezer controls to the recommended (middle) settings by pressing REFRIGERATOR Graphic and FREEZER Graphic.

**NOTE:** When changing control settings, wait 24 hours before making additional adjustments. After 24 hours, adjust the compartments temperatures as desired. The more lit bars, the colder the refrigerator and freezer will be.



## Display Off Mode

The display lights up and stays lit when the refrigerator is plugged in for 60 seconds. After the display lights all off except the dispenser icon selected (CRUSH, WATER or CUBE) and the display only lights when door is opened or display button is pressed. Display turn off 20 seconds after door is closed or display button pressed. You can change the display always ON pressing "FREEZER" and "ICE PLUS" buttons at the same time for 5 seconds. A tone will sound indicating that the display is ON (Display Off Mode Deactivate). Activate the Display Off Mode in same manner as deactivation.

## ICE TYPE

You can select water or ice.



Select Water, Crushed Ice or Cubed Ice by pressing the ICE TYPE button to the selection desired. The Water, Crushed Ice or Cubed Ice icon will light up to indicate selection.



Light up the cubed ice lamp by pressing the selection button. The dot will be illuminated.



Light up the water lamp by pressing the selection button. The dot will be illuminated.



Light up the crushed ice lamp by pressing the selection button. The dot will be illuminated.

## USING YOUR REFRIGERATOR

To dispense water or ice, gently push your cup against the dispenser pad.

**NOTE:** Hold your cup in place for a couple of seconds after dispensing ice or water so the last few drops go in your cup instead of on the floor.

### DOOR ALARM

When either refrigerator or freezer door is left open for more than 60 seconds, an alarm will sound 5 times at thirty-second intervals to let you know the door is open. The alarm will repeat every 30 seconds until all doors are completely closed. Please contact the local service center if warning tone continues to sound even after closing the door.



### FILTER (Filter Replacement Cycle)

There is an indicator light for the water filter cartridge on the dispenser that will blink to indicate it is time to change the water filter. Water filters usually need to be replaced once every six months. After replacing the filter, press and hold the Filter Reset button for 3 seconds to turn off the filter status light.



### LOCK

The Lock button deactivates the temperature controls and dispenser functions. Press and hold this button for 3 seconds or until the Lock indicator light is lit. To disable the Lock function, press and hold the filter button for seconds or until the Lock indicator light is off.



### ICE PLUS

Press this button once to activate the increased ice making function. The ICE PLUS icon on the display panel will illuminate when activated. The Ice Plus function runs the freezer compartment at the coldest settings for a 24 hour period to increase ice making. Press the button again to cancel the Ice Plus function.

### ADJUSTING CONTROL SETTINGS

Give the refrigerator time to cool down completely before making final adjustments. It is best to wait 24 hours before doing this. The initial settings mentioned in "Control Panel Features" section should be correct for normal household refrigerator use.

The refrigerator control functions as the thermostat for the entire appliance (refrigerator and freezer sections). The colder the setting, compressor will the longer the run to keep the temperature colder. The freezer control adjusts the cold air flow from the freezer to the refrigerator. Setting the freezer control to a lower temperature keeps more cold air in the freezer compartment to make it colder.

If you need to adjust temperatures in the refrigerator or freezer, start by adjusting the refrigerator and allow 24 hours for the temperature to stabilize. If it is too warm or too cold, then adjust the freezer control. Use the settings listed in the chart below as a guide. Always remember to

wait at least 24 hours between adjustments.

CONDITION/REASON:	RECOMMENDED ADJUSTMENT:
<b>REFRIGERATOR section is too warm</b> <ul style="list-style-type: none"> <li>Opening the door often</li> <li>Adding a large amount of food</li> <li>Room temperature is very warm</li> </ul>	<b>Adjust the REFRIGERATOR setting to the next highest number and wait 24 hours, then check.</b>
<b>FREEZER section is too warm/ ice is made too slowly</b> <ul style="list-style-type: none"> <li>Opening the door often</li> <li>Adding a large amount of food</li> <li>Room temperature is very low (not cycling often enough)</li> <li>Using ice frequently</li> <li>Air vents blocked by objects</li> </ul>	<b>Adjust the FREEZER setting to the next highest number and wait 24 hours, then check.</b>  <b>Remove any objects blocking air flow.</b>
<b>REFRIGERATOR section is too cold</b> <ul style="list-style-type: none"> <li>Controls not set correctly for your conditions</li> </ul>	<b>Adjust the REFRIGERATOR setting to the next lowest number and wait 24 hours, then check.</b>
<b>FREEZER section is too cold</b> <ul style="list-style-type: none"> <li>Controls not set correctly for your conditions</li> </ul>	<b>Adjust the FREEZER setting to the next lowest number and wait 24 hours, then check.</b>

### ICE MAKER OPERATION

#### ⚠ WARNING

##### PERSONAL INJURY HAZARD

Avoid contact with the moving parts of the ejector mechanism, or with the heating element that releases the cubes. **DO NOT** place fingers or hands on the automatic ice making mechanism while the refrigerator is plugged in.

A newly-installed refrigerator may take 12 to 24 hours to begin making ice.

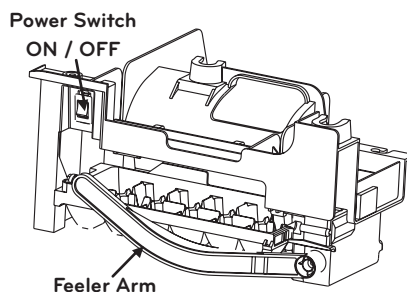

## USING YOUR REFRIGERATOR

The ice maker will produce 12 cubes per cycle, approximately 140-150 cubes in a 24 hour period, depending on freezer compartment temperature, room temperature, number of door openings and other operating conditions.

If the refrigerator is used before the water connection is made to the ice maker, set the power switch to **OFF (O)**. Throw away the first few batches of ice to allow the water line to clear.

Be sure nothing interferes with the sweep of the feeler arm. When the bin fills to the level of the feeler arm, the ice maker will stop producing ice.

It is normal for several cubes to be stuck together. If ice is not used frequently, old ice cubes will become cloudy, taste stale and shrink.

### FOOD STORAGE GUIDE

Wrap or store food in the refrigerator in airtight and moisture-proof material unless otherwise noted. This prevents food odor and taste transfer throughout the refrigerator. For dated products, check date code to ensure freshness.

ITEMS	HOW TO STORE
<b>Storing Fresh Food</b>	Wrap or store food in the refrigerator in airtight and moisture-proof material unless otherwise noted. This prevents food odor and taste transfer throughout the refrigerator. For dated products, check date code to ensure freshness.
<b>Butter or margarine</b>	Store opened butter in a covered dish or in a closed compartment. When storing a larger quantity, wrap in freezer packing and freeze.
<b>Cheese</b>	Store in original packaging until you are ready to use it. Once opened, tightly rewrap with plastic wrap or aluminum foil.
<b>Vegetables with skins (carrots, peppers)</b>	Place in bags or plastic containers inside the crisper.
<b>Fruit</b>	Wash and let dry; store in plastic bags in the refrigerator. Do not wash or pit berries until you are ready to eat them. Berries should be selected and kept in their original packaging (if there is any) or in a paper bag closed halfway and set on a shelf.
<b>Leafy Vegetables</b>	Remove original packaging and trim any dirty or discolored parts. Wash in cold water and drain. Place in a plastic bag or plastic container and store in the crisper.

ITEMS	HOW TO STORE
<b>Fish</b>	Consume fish or seafood the same day purchased.
<b>Chef Fresh</b>	Store any meat in original airtight, moisture-proof packaging. Rewrap if necessary.
<b>Leftovers</b>	Cover leftovers with plastic wrap or aluminum foil. Plastic containers with airtight lids can also be used.

### STORING FROZEN FOOD

**NOTE:** For further information about preparing food for freezing or food storage times, check a freezer guide or a reliable cookbook.

#### Packaging

Successful freezing depends on correct packaging. When you close and seal the package, it must not allow air or moisture in or out. If it does, you could have food odor and taste transfer throughout the refrigerator and also dry out frozen food.

#### Packaging Recommendations:

- Rigid plastic containers with "tight-fitting lids".
- Straight-sided canning/freezing jars.
- Heavy-duty aluminum foil.
- Plastic-coated paper.
- Non-permeable plastic wraps.
- Specified freezer-grade self-sealing plastic bags.

Follow package or container instructions for proper freezing methods.

#### Do not use:

- Bread wrappers
- Containers without tight lids
- Wax paper or wax-coated freezer wrap
- Thin, semi-permeable wrap

**⚠ CAUTION:** Do not keep beverage cans or plastic food containers in the freezer compartment. They may burst if they freeze.

#### Freezing

Your freezer will not quick-freeze any large quantity of food. Do not put more unfrozen food into the freezer than will freeze within 24 hours [no more than 2 to 3 lbs of food per cubic foot (0,9 to 1,35 kg per cubic meter) of freezer space]. Leave enough space in the freezer for air to circulate around packages. Be careful to leave enough room at the front so the door can close tightly.

Food storage times will vary according to the quality and type of food, the type of packaging or wrap used (airtight and moisture-proof) and the storage temperature. Ice crystals inside a sealed package are normal. This simply means that moisture in the food and air inside the package have condensed, creating ice crystals.

**NOTE:** Allow hot foods to cool at room temperature for 30 minutes, then package and freeze. Cooling hot foods before freezing saves energy.

## USING YOUR REFRIGERATOR

### WATER AND ICE DISPENSER

Your refrigerator has a mechanism that dispatch cool water and ice cubes without open the door.

- Tray can be easily removed by pressing and pulling it.
- First push the tray in the area with the word 'PUSH'; then place your finger in the center hole and upwards, finally takes out the tray.

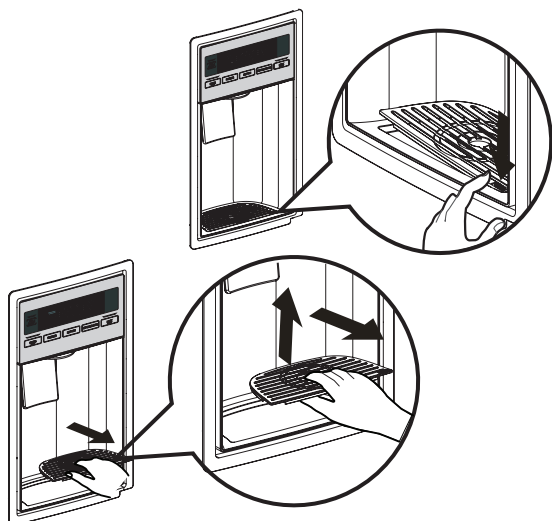

#### ⚠ WARNING

Do not put your hands into the water & ice dispenser opening. Doing so may cause an injury to your hand.

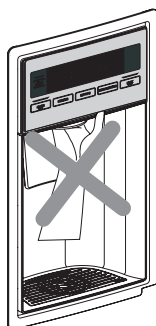

#### ⚠ CAUTION

When opening the container with the small opening, use it near the opening of the water or ice dispenser as close as possible.



### ICE STORAGE BIN

The ice bin stores the ice cubes made by the ice maker. If you need to remove the ice storage bin, do so as follows:

**NOTE:** Use both hands to remove the ice bin to avoid dropping it. If the ice bin does not slide into place easily, twist the drive device slightly.

- Hold the ice storage bin ① and pull it out while slightly lifting it ② shown in the figure.
- To assemble the ice storage bin, push it ③ while slightly lifting it ④.
- Make sure it is fully engaged into the auger drive ⑤.

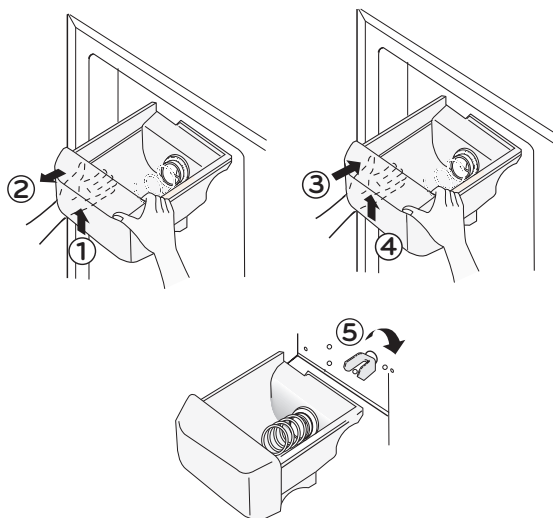

### ICE MAKER COVER

If you need access to the ice maker, follow these steps:

- Lift the ice shelf ① and pull it ② out as shown in the figure below.

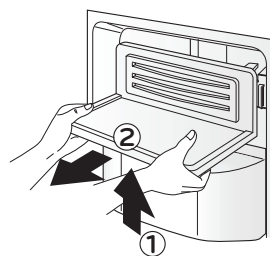

### DOOR RACK AND SUPPORT

Your refrigerator and freezer features racks which can easily be arranged for packaged products.

- Lift the door rack holding both sides ① and pull it out in ② direction.

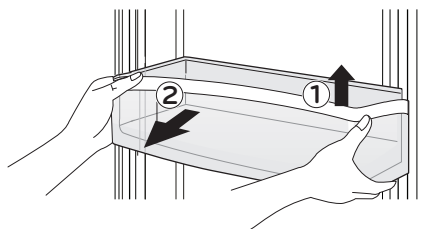

### SNACK PAN (in some models)

- To remove the snack pan cover, pull out the snack pan compartment a bit to the front ①, then lift the front part of the snack pan compartment later raises a little the snack pan compartment until it leaves the top of the shelf as shown in ②, and take it out.

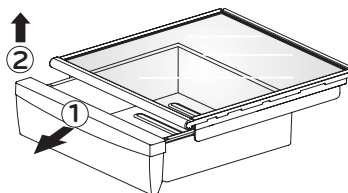



## USING YOUR REFRIGERATOR

### CRISPER AND CRISPER COVER

The crisper allows for better conservation of fruits and vegetables.

- To remove the crisper compartment cover, pull out the crisper compartment a bit to the front ①, lift the front part of the cover as shown in ②, and take it out ③.

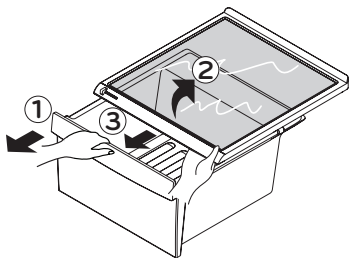

- To remove the crisper compartment, pull the crisper compartment to the front ① until it stops. Then slightly lift the crisper compartment ② while pulling it out ③.

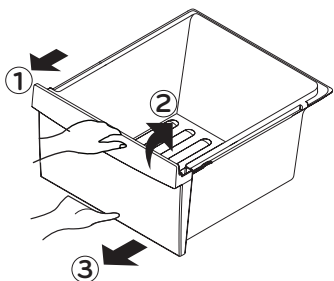

#### ⚠ CAUTION

When removing the crisper compartment you will see the water tank. Do not remove it, or water leakage may result. The water tank is not a removable part.

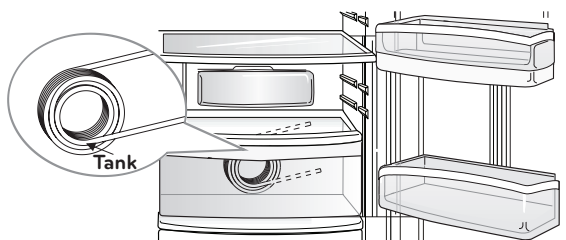

### HUMIDITY CONTROLS

You can control the amount of humidity in the moisture sealed crispers. Adjust the control to any setting between "HIGH" and "LOW".

**"HIGH"**: Keeps moist air in the crisper for best storage of fresh, leafy vegetables.

**"LOW"**: Keeps moist air out of the crisper for best storage of fruits or vegetables with skins.

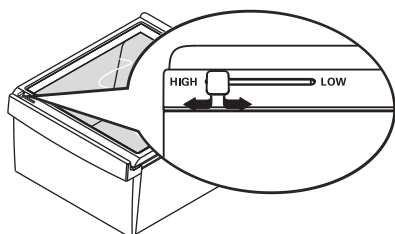

### REFRIGERATOR SHELVES

#### ⚠ CAUTION

Make sure to keep shelf horizontal while removing; otherwise it may drop.

The refrigerator compartment shelf is adjustable so that you can place it at a height according to space requirement of foods.

#### Sliding out Shelf:

Pull the shelf towards you ①, then lift both front and rear ② while taking it out ③.

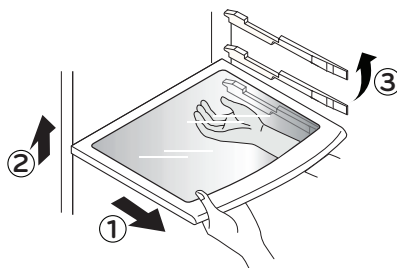

#### ⚠ CAUTION

Be careful when pulling out the shelf. If you apply too much force, it may hit the refrigerator door and damage it or you could hurt yourself.

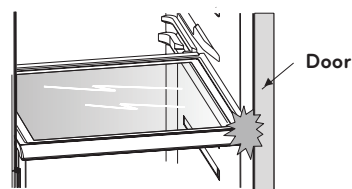

#### Fixed Shelf:

- Lightly lift up the front part of the shelf ① to pull it towards you ②, then take it out while lifting the rear part of shelf ③.

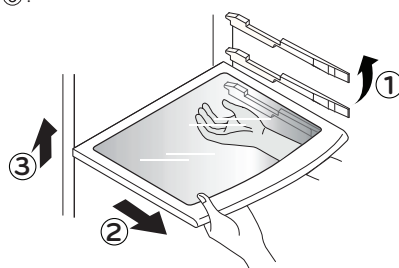

### FREEZER SHELF

To assemble or disassemble the freezer shelf, follow the next steps:

- Lift the left part of the shelf a bit. Lift it to the direction ①, push the right part to the direction ② and take it out.

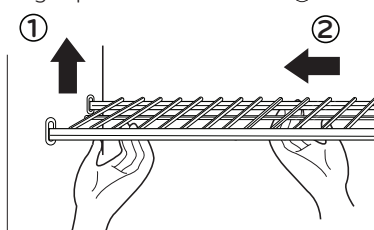

# FILTER

## WATER FILTER

**Filter Reset:** When the filter icon turns on, you have to change the water filter. Press the Filter button for 3 seconds to turn the icon off.



- Push the water filter up into the filter receptacle and rotate it clockwise to lock it into place. Once installed correctly, the lock symbol  should be facing you and you should not be able to rotate the filter clockwise anymore.

### Before removing or installing water filter:

- **IMPORTANT:** Turn off household water supply.
- Take out the top shelf and move it to the lowest level.

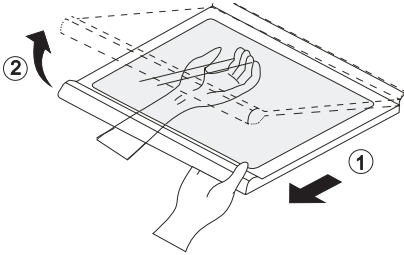

### Removing the Water Filter

- Remove old filter by turning it counterclockwise a quarter turn and pulling it down. The substitute cap must be retained for the future. If the filter is removed and not replaced, it is necessary to reinstall the substitute cap to prevent water leaks from the filter housing.

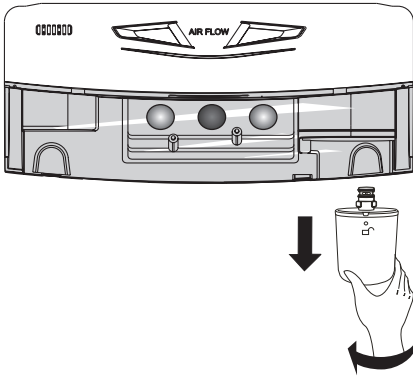

**NOTE:** After installation, if you notice that the lock symbol  is not facing you or you can continue to rotate the filter clockwise; remove the filter and repeat installation to prevent water leaks.

### After installing the Water Filter

- Replace the shelf to the initial position.
- After installing filter, turn on household water supply.
- Dispense 2,5 gallons (9,46 liters) of water to purge the system, depressing and releasing the dispenser pad in cycles of 30 seconds ON and 60 seconds OFF. Open the refrigerator door and check the shelf area for water leaks.

To purchase or replace water filters, call your Service Center. Refer to the Warranty Card to obtain the telephone number of the Service Center near you and ask for part no. 5231JA2002A or ADQ72910901.

### Installing the Water Filter

- Remove the red cap from the filter.
- Hold the filter with the unlock symbol  facing towards you as shown in the figure below. Insert the filter into the filter receptacle on the right side of the refrigerator compartment.

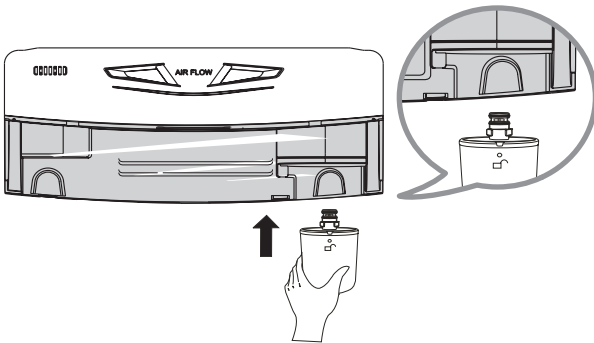

# FILTER

## Performance Data Sheet Models Number 5231JA2002A-S

### Use with replacement cartridge 5231JA2002A

This system has been tested according to NSF/ANSI Standards 42 for the reduction of the substances listed below. The concentration of the indicated substances in water entering the system was reduced to a concentration less than or equal to the permissible limit for water leaving the system as specified in NSF/ANSI 42.



System tested and certified by NSF International against NSF/ANSI Standard 42 for the reduction of Chlorine Taste and Odor and Nominal Particulate Class III.

Capacity: 500 gal (1,892 L)

Substance	Average Influent Concentration	Influent Challenge Concentration. Units apply to each row	Avg. Product Water Concentration	Average % Reduction	NSF % reduction req. or Max permissible product water concentration
Nominal Particulate Class I Particle size: >0.5 to <1 um	24,333	At least 10,000 particles/ml	915	96	≥ 85%
Chlorine taste and odor Class III	1,9	2.0 mg/L ± 10%	0,07	96,4	≥ 50%

Note that while the testing was performed under standard laboratory conditions, actual performance may vary.

Application Guidelines / Water Supply Parameters	
Service flow	0,5 gpm (1,89 lpm)
Water pressure	20 - 125 psi (138 - 862 kPa)
Water temperature	33 °F - 100 °F (0,6 °C - 38 °C)

**⚠ WARNING**

To reduce the risk associated with ingestion of contaminants due to use with water that is micro biologically unsafe or of unknown quality. Do not use with water that is micro biologically unsafe or of unknown quality without adequate disinfection before or after the system.

Systems must be installed and operated in accordance with manufacturer's recommended procedures and guidelines.

**⚠ CAUTION**

To reduce the risk of property damage due to water leakage:

- Read and follow Use instructions before installation and use of this system.
- Install on COLD water lines only. Comply with all state and local plumbing codes.
- Install a pressure limiting device and water hammer arrester for inlet water pressures exceeding 80 psi (552 kPa). Refer to Uniform Plumbing Code, Sections 608.2 and 609.10.
- Never install or operate where inlet water pressure may exceed 120 psi (827 kPa).
- Protect filter from freezing. Remove filter in temperatures below 33 °F (0.6 °C).
- Replace cartridge at specified service interval. Cartridge MUST be replaced at least every 6 months.

To purchase or replace water filters call your Service Center. Refer to the Warranty Card to obtain the telephone number of the Service Center near you and ask for part no. 5231JA2002A or ADQ72910901.

## CARE AND CLEANING

<p><b>⚠ WARNING</b></p> <p><b>EXPLOSION HAZARD</b></p> 
<p>Use non-flammable cleaner. Failure to do so can result in death, explosion, or fire.</p>

Both the refrigerator and freezer sections defrost automatically. However, clean both sections about once a month to prevent odors. Wipe up spills immediately.

### GENERAL CLEANING TIPS

- Unplug refrigerator or disconnect power.
- Remove all removable parts, such as shelves, crispers, etc. Refer to sections in **"Using Your Refrigerator"** for removal instructions.
- Use a clean sponge or soft cloth and a mild detergent in warm water. Do not use abrasive or harsh cleaners.
- Hand wash, rinse and dry all surfaces thoroughly.
- Plug in refrigerator or reconnect power.

### OUTSIDE

Waxing external painted metal surfaces helps provide rust protection. Do not wax plastic parts. Wax painted metal surfaces at least twice a year using appliance wax (or auto paste wax). Apply wax with a clean, soft cloth.

Do not use wax on stainless steel exteriors. Use a product specially designed for polishing stainless steel appliances, or clean with a soft cloth or clean sponge and a mild detergent dissolved in warm water. Dry thoroughly with a soft cloth.

**NOTE:** Avoid door surface contact with chemical products that contain Phosphate or Chlorine, such as degraders, detergents (containing TSP) and bleaches.

### INSIDE WALLS

**NOTE:** Allow freezer to warm up so cloth will not stick.

To help remove odors, you can wash the inside of the refrigerator with a mixture of baking soda and warm water. Mix 2 tablespoons baking soda to 1 quart of water (26 g soda to 1 liter water.) Be sure the baking soda is completely dissolved so it does not scratch the surfaces of the refrigerator.

### DOOR LINERS AND GASKETS

Do not use cleaning waxes, concentrated detergent, bleaches, or cleaners containing petroleum on plastic refrigerator parts. Use a clean sponge or soft cloth and a mild detergent in warm water. Wash, rinse and dry all surfaces thoroughly.

### PLASTIC PARTS (covers and panels)

Do not use window sprays, abrasive cleaners, or flammable fluids. These can scratch or damage the material. Use a clean sponge or soft cloth and a mild detergent in warm water. Wash, rinse and dry all surfaces thoroughly.

### BACK COVER

<p><b>⚠ WARNING</b></p> <p><b>ELECTRICAL SHOCK HAZARD</b></p> <p>Before you begin, either unplug the refrigerator or turn off power at the circuit breaker or fuse box. Failure to do so could result in death or serious injury</p>
--

**NOTE:** Back Cover should only be removed by a qualified technician.

Clean the vents on the back cover. Use a vacuum cleaner with the brush attachment, at least twice a year to keep your refrigerator working efficiently.

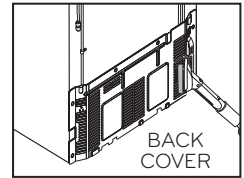

### LIGHT (LED) REPLACEMENT

**NOTE:** Do not remove the LED, it is only to be removed by a qualified technician.

### POWER INTERRUPTIONS

1. If the power will be out for 24 hours or less, keep all refrigerator doors closed to help foods stay cold and frozen.
2. If the power will be out for more than 24 hours:
  - a) Remove all frozen food and store it in a frozen food locker.

### OR

- b) Place 2 lbs. (1 kg) of dry ice in the freezer for every cubic foot (28 L) of freezer space. This will keep the food frozen for two to four days. While handling dry ice, wear gloves to protect your hands from frostbite.

<p><b>⚠ WARNING</b></p> <p><b>SUFFOCATION HAZARD</b></p> <p>When using dry ice, provide adequate ventilation, Dry ice is frozen carbon dioxide (CO<sub>2</sub>). When it vaporizes, it can displace oxygen, causing dizziness, light-headedness, unconsciousness and death by suffocation. Open a window and do not breathe the vapors.</p>
---

### OR

- c) If neither a food locker nor dry ice is available, consume or dispose of food at once.

**REMEMBER:** In a power failure, a full freezer stays cold longer than a partially filled one. If you see that food contains ice crystals, it may be affected. If the condition of the food is poor, or if you feel it is unsafe, dispose of it.

## CARE AND CLEANING

### **WARNING**

**DO NOT** refreeze frozen foods which have thawed completely. The United States Department of Agriculture in Home and Garden Bulletin No. 69 says: ...You may safely refreeze frozen foods that have thawed if they still contain ice crystals or if they are still cold-below 40 °F (4 °C). ...Thawed ground meats, poultry or fish that have any off-odor or off-color should not be frozen and should not be eaten. Thawed ice cream should be discarded.

If the odor or color of any food is poor or questionable, dispose of it. The food may be dangerous to eat. Even partial thawing and refreezing reduces the eating quality of foods, particularly fruits, vegetables and prepared foods.

The eating quality of red meats is affected less than that of many other foods. Use refrozen foods as soon as possible to save as much of their quality as you can.

### **WHEN YOU GO ON VACATION**

**If you choose to leave the refrigerator ON while you are away**, follow these steps to prepare your refrigerator before you leave.

1. Use up any perishables and freeze other items.
2. Empty the ice bin.
3. Turn OFF the Ice maker. **NOTE:** If the ambient temperature will drop below freezing, have a qualified service technician drain the water supply system (on some models) to prevent serious property damage due to possible flooding from ruptured water lines or connections.

**If you choose to turn the refrigerator OFF before you leave**, follow these steps:

1. Remove all food from the refrigerator and empty ice bin.
2. Unplug refrigerator.
3. Clean refrigerator, wipe, and dry well.
4. Tape rubber or wood blocks to the tops of both doors to prop them open far enough for air to get in. This stops odor and mold from building up.

### **WHEN YOU MOVE**

When you are moving your refrigerator to a new home, follow these steps to prepare it for the move.

1. Remove all food from the refrigerator and pack all frozen food in dry ice.
2. Unplug refrigerator.
3. Clean refrigerator, wipe, and dry well.
4. Empty water from the defrost pan.
5. Clean, wipe and dry thoroughly.
6. Take out all removable parts, wrap them well and tape together so they don't shift and rattle during the move. Refer to sections in Using your Refrigerator for removal instructions.
7. Depending on the model, raise the front of the refrigerator so it rolls more easily OR screw in the leveling legs all the way so they don't scrape the floor. See the "**Door Alignment**" section.
8. Tape the doors shut and tape the power cord to the refrigerator cabinet.

When you get to your new home, put everything back and refer to the "**Refrigerator Installation**" section for setup instructions.

### **WHEN YOU SHOULD SET THE ICE MAKER POWER SWITCH TO OFF (O)**

- When the water supply will be shut off for several hours.
- When the ice storage bin is removed for more than a minute or two.
- When the refrigerator will not be used for several days.

### **NORMAL SOUNDS YOU MAY HEAR**

- The ice maker water valve will buzz as the ice maker fills with water. If the power switch is in the **ON** position, it will buzz even if it has not yet been hooked up to water. To stop the buzzing, move the power switch to **OFF** position.

**NOTE:** Keep the power switch in the **ON** position before the water line is connected can damage the ice maker.

- You will hear the sound of cubes dropping into the bin and water running in the pipes as the ice maker refills.

## TROUBLESHOOTING GUIDE

### UNDERSTANDING SOUNDS YOU MAY HEAR

Your new refrigerator may make sounds that your old one did not make. Because the sounds are new to you, you might be concerned about them. Most of the new sounds are normal. Hard surfaces, like the floor, walls and cabinets, can make the sounds seem louder than they actually are. The following list describes the kinds of sounds and what may be making them.

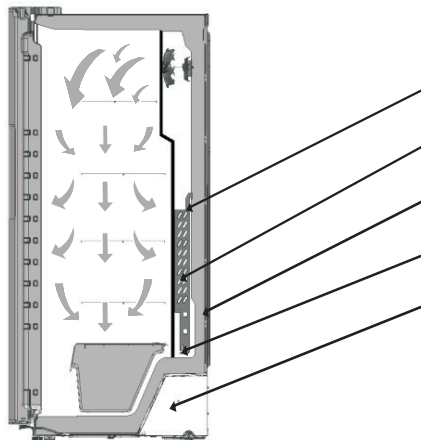

- The defrost timer will click when the automatic defrost cycle begins and ends. The thermostat control (or refrigerator control, depending on the model) will also click when cycling on and off.
- Rattling noises may come from the flow of refrigerant, the water line, or items stored on top of the refrigerator.
- Your refrigerator is designed to run more efficiently to keep your food items at the desired temperature. The high efficiency compressor may cause your new refrigerator to run longer than your old one, and you may hear a pulsating or high-pitched sound.
- You may hear the evaporator fan motor circulating the air through the refrigerator and freezer compartments.
- As each cycle ends, you may hear a gurgling sound due to the refrigerant flowing in your refrigerator.
- Contraction and expansion of the inside walls may cause a popping noise.
- Water dripping on the defrost heater during a defrost cycle may cause a sizzling sound.
- You may hear air being forced over the condenser by the condenser fan.
- You may hear water running into the drain pan during the defrost cycle.

Problem	Possible Causes	Solutions
<b>REFRIGERATOR DOES NOT OPERATE</b>	<ul style="list-style-type: none"> <li>• The power supply cord is unplugged.</li> <li>• A household fuse has blown or circuit breaker tripped.</li> <li>• The refrigerator control is set to the OFF position.</li> <li>• Refrigerator is in the defrost cycle.</li> </ul>	<ul style="list-style-type: none"> <li>• Firmly plug the cord into a live outlet with proper voltage.</li> <li>• Replace the fuse or reset the circuit breaker.</li> <li>• Refer to the <b>"Control Panel Features"</b> section.</li> <li>• Wait about 30 minutes for defrost cycle to end.</li> </ul>
<b>VIBRATION OR RATTLING NOISE</b>	<ul style="list-style-type: none"> <li>• The refrigerator is not resting solidly on the floor.</li> </ul>	<ul style="list-style-type: none"> <li>• Floor is weak or uneven or leveling legs need adjusting. See <b>"Door Alignment"</b> Section.</li> </ul>
<b>LED (LAMP) DO NOT WORK</b>	<ul style="list-style-type: none"> <li>• The power supply cord is unplugged.</li> <li>• LED Light has burned out.</li> </ul>	<ul style="list-style-type: none"> <li>• Firmly plug the cord into a live outlet with proper voltage.</li> <li>• See the <b>"Light (LED) Replacement"</b> section.</li> </ul>
<b>COMPRESSOR MOTOR SEEMS TO RUN TOO MUCH</b>	<ul style="list-style-type: none"> <li>• The refrigerator that was replaced was an older model.</li> <li>• The room temperature is hotter than normal.</li> <li>• The refrigerator was recently plugged in and the refrigerator control was set correctly.</li> <li>• The door is opened often or a large amount has just been added.</li> <li>• The refrigerator control was not set correctly for the surrounding conditions.</li> </ul>	<ul style="list-style-type: none"> <li>• Modern refrigerators with more storage space require more operating time.</li> <li>• The motor will run longer under warm conditions. At normal room temperatures, expect your motor to run about 40% to 80% of the time. Under warmer conditions, expect it to run even more often.</li> <li>• The refrigerator will take up to 24 hours to cool completely.</li> <li>• Adding food and opening the door warms the refrigerator. It is normal for the refrigerator to run longer in order to conserve energy, try to get everything you need out of the refrigerator at once, keep food organized so it is easy to find and close the door as soon as the food is removed. See the <b>"Food Storage Guide"</b> section.</li> <li>• See the <b>"Adjusting Control Settings"</b> Section.</li> </ul>

## TROUBLESHOOTING GUIDE

Problem	Possible Causes	Solutions
<b>COMPRESSOR MOTOR SEEMS TO RUN TOO MUCH</b>	<ul style="list-style-type: none"> <li>• The doors are not closed completely.</li> <li>• The condenser coils are dirty.</li> </ul>	<ul style="list-style-type: none"> <li>• Push the doors firmly shut. If they will not shut all the way, see Doors will not close completely below.</li> <li>• This prevents air transfer and makes the motor work harder. Clean the condenser coils. Refer to the <b>"Care and Cleaning"</b> section.</li> </ul>
<b>DOORS WILL NOT CLOSE COMPLETELY</b>	<ul style="list-style-type: none"> <li>• The refrigerator is not level.</li> <li>• Food packages are blocking the door open.</li> <li>• The ice bin, crisper cover, pans, shelves, door bins or baskets are out of position.</li> <li>• The gaskets are sticking.</li> <li>• The refrigerator wobbles or seems unstable.</li> <li>• The doors were removed during product installation and not properly replaced.</li> </ul>	<ul style="list-style-type: none"> <li>• See the <b>"Refrigerator Installation"</b> and <b>"Door Alignment"</b> sections to level refrigerator.</li> <li>• Rearrange food containers to clear door and door shelves.</li> <li>• Push bins all the way in and put crisper cover, pans, shelves and baskets into their correct positions. See the <b>"Using your Refrigerator"</b> Section.</li> <li>• Clean gaskets and the surface that they touch. Rub a thin coat of paraffin wax on the gaskets after cleaning.</li> <li>• Level the refrigerator. Refer to the <b>"Door Alignment"</b> section.</li> <li>• Remove and replace the doors according to the <b>"Removing and Replacing Refrigerator Doors"</b> section or call qualified service technician.</li> </ul>
<b>THE DOORS ARE DIFFICULT TO OPEN</b>	<ul style="list-style-type: none"> <li>• The gaskets are dirty or sticky.</li> <li>• The door is reopened within a short time after having been opened.</li> </ul>	<ul style="list-style-type: none"> <li>• Clean gaskets and the surfaces that they touch. Rub a thin coat of appliance polish or kitchen wax on the gaskets after cleaning.</li> <li>• When you open the door, warmer air enters the refrigerator. As the warm air cools, it can create a vacuum. If the door is hard to open, wait 5 minutes to allow the air pressure to equalize, then see if it opens more easily.</li> </ul>
<b>TEMPERATURE IS TOO WARM OR THERE IS INTERIOR MOISTURE BUILDUP</b>	<ul style="list-style-type: none"> <li>• The doors are opened often.</li> <li>• The control is not set correctly for the surrounding conditions.</li> <li>• A large amount of food has just been added to the refrigerator or freezer.</li> <li>• The food is not packaged correctly.</li> <li>• The doors are not closing completely.</li> <li>• The weather is humid.</li> <li>• A self-defrost cycle was completed.</li> <li>• The air vents are blocked. Cold air circulates from the freezer to the fresh food section and back again through air vents in the wall dividing the two sections.</li> </ul>	<ul style="list-style-type: none"> <li>• When the door is opened, warm humid air is allowed into the refrigerator. The more the door is opened, the faster the humidity builds up, and the more warm air the refrigerator must cool. In order to keep the refrigerator cool, try to get everything you need out of the refrigerator at once, keep food organized so it is easy to find and close the door as soon as the food is removed.</li> <li>• Refer to the <b>"Control Panel Features"</b>. Wait 24 hours for temperatures to stabilize or even out. If the temperature is too cold or too warm, adjust the setting one level at a time.</li> <li>• Adding food warms the refrigerator. It can take a few hours for the refrigerator to return to normal temperature.</li> <li>• Wrap food tightly and wipe off damp containers prior to storing in the refrigerator to avoid moisture accumulation. If necessary, repackage food according to the guidelines in the <b>"Food Storage Guide"</b> section.</li> <li>• See <b>"Doors will not close completely"</b>.</li> <li>• In humid weather, air carries moisture into refrigerator when doors are opened.</li> <li>• It is normal for droplets to form on the back wall after the refrigerator self-defrosts.</li> <li>• Locate air vents by using your hand to sense airflow and move all packages that block vents and restrict airflow. Refer to <b>"Ensuring Proper Air Circulation"</b> section for the location of air vents.</li> </ul>

## TROUBLESHOOTING GUIDE

Problem	Possible Causes	Solutions
<b>CUBES PRODUCED BY ICE MAKER ARE TOO SMALL</b>	<ul style="list-style-type: none"> <li>Water shutoff valve connecting refrigerator to water line may be clogged.</li> </ul>	<ul style="list-style-type: none"> <li>Call a plumber to clear the valve.</li> </ul>
<b>ICE HAS BAD TASTE OR ODOR</b>	<ul style="list-style-type: none"> <li>The ice maker was recently installed.</li> <li>The ice has been stored for too long.</li> <li>The food has not been wrapped tightly in either compartment.</li> <li>The water supply contains minerals such as sulfur.</li> <li>The interior of refrigerator needs cleaning.</li> <li>Ice storage bin needs cleaning.</li> </ul>	<ul style="list-style-type: none"> <li>Discard first few batches of ice to avoid discolored or off-flavored ice.</li> <li>Throw away old ice and make new supply.</li> <li>Rewrap foods since odors may migrate to the ice if food is not wrapped properly.</li> <li>A new filter may need to be installed to eliminate taste and odor problems.</li> <li>See <b>"Care and Cleaning"</b> section.</li> <li>Empty and wash bin. Discard old cubes.</li> </ul>
<b>THERE IS WATER IN THE DEFROST DRAIN PAN</b>	<ul style="list-style-type: none"> <li>The refrigerator is defrosting.</li> <li>It is more humid than normal.</li> </ul>	<ul style="list-style-type: none"> <li>The water will evaporate. It is normal for water to drip into the defrost pan.</li> <li>Expect that the water in the defrost pan will take longer to evaporate. This is normal when it is hot or humid.</li> </ul>
<b>THE REFRIGERATOR SEEMS TO MAKE TOO MUCH NOISE</b>	<ul style="list-style-type: none"> <li>The sounds may be normal for your refrigerator.</li> </ul>	<ul style="list-style-type: none"> <li>Refer to the <b>"Understanding sounds you may hear"</b> section.</li> </ul>
<b>FROST OR ICE CRYSTALS ON FROZEN FOOD</b>	<ul style="list-style-type: none"> <li>The door is not closing properly.</li> <li>The door is opened often.</li> </ul>	<ul style="list-style-type: none"> <li>See <b>"Doors will not close completely"</b> above.</li> <li>When the door is opened, warm, humid air is allowed in the freezer resulting in frost.</li> </ul>
<b>THE ICE MAKER IS NOT PRODUCING ICE OR ICE CUBES ARE FREEZING TOO SLOWLY</b>	<ul style="list-style-type: none"> <li>The freezer temperature is cold enough to produce ice.</li> <li>Door left open.</li> </ul>	<ul style="list-style-type: none"> <li>Wait 24 hours after hook-up for ice production. See the <b>"Control Panel Features"</b> section.</li> <li>Check to see if something is holding the door open.</li> </ul>
<b>AUTOMATIC ICE MAKER DOES NOT WORK</b>	<ul style="list-style-type: none"> <li>Ice maker power switch on <b>OFF (O)</b> position.</li> <li>Water supply turned off or not connected.</li> <li>Freezer compartment too warm.</li> <li>Piled up the cubes in the storage bin cause the ice maker to shut off.</li> </ul>	<ul style="list-style-type: none"> <li>Move the switch to the <b>ON (I)</b> position.</li> <li>See the <b>"Connecting the Water Line"</b> section.</li> <li>Wait 24 hours for the freezer to reach its ideal temperature.</li> <li>Level cubes by hand or shake the bin occasionally.</li> </ul>
<b>NOT DISPENSING ICE</b>	<ul style="list-style-type: none"> <li>All the doors are not closed completely.</li> <li>The dispenser display is locked.</li> <li>Ice is not selected on the dispenser.</li> <li>The ice dispenser is not used often.</li> <li>Ice bin is not installed correctly.</li> <li>New installation.</li> <li>Ice cubes are stuck in the delivery chute.</li> </ul>	<ul style="list-style-type: none"> <li>Ice will not dispense if any of the refrigerator doors are left open.</li> <li>Press and hold the Lock button for 3 seconds to unlock the control panel and dispenser.</li> <li>The dispenser can be set for ice or water. Make certain that the control panel is set for the proper operation. Press the dispenser button on the control panel to cycle through the ice and water options.</li> <li>Check the ice bin for ice cubes clumping/ sticking together. If they are, break up the ice cubes allow for proper operation.</li> <li>Be sure to install the ice bin firmly into position.</li> <li>Wait 24 hours after ice maker installation for ice production to begin. Wait 72 hours for full ice production.</li> <li>Use a plastic utensil to clear the delivery chute.</li> </ul>



## TROUBLESHOOTING GUIDE

Problem	Possible Causes	Solutions
<b>CUBES PRODUCED BY ICE MAKER ARE TOO SMALL</b>	<ul style="list-style-type: none"> <li>• The ice dispenser is stalling while dispensing "crushed" ice.</li> <li>• Ice maker power switch in the OFF (O) position.</li> <li>• Water supply turned off or not connected.</li> </ul>	<ul style="list-style-type: none"> <li>• Change the ice button from "crushed" to "cubed". If cubed ice dispenses correctly, depress the button for "crushed" ice and begin dispensing again.</li> <li>• Move the switch to the ON (I) position.</li> <li>• See the "Connecting the Water Line" section.</li> </ul>
<b>ICE HAS BAD TASTE OR ODOR</b>	<ul style="list-style-type: none"> <li>• The dispenser display is locked.</li> <li>• New installation.</li> <li>• Refrigerator or freezer doors are not closed properly.</li> <li>• Water supply turned off or not connected.</li> <li>• The water pressure is less than 40 PSI.</li> <li>• Home filter or reverse osmosis system is used.</li> <li>• The dispenser is not set for water dispensing.</li> </ul>	<ul style="list-style-type: none"> <li>• Press and hold the Lock button for 3 seconds to unlock the control panel and dispenser.</li> <li>• Flush and fill the water system.</li> <li>• Water will not dispense if any of the refrigerator doors are left open.</li> <li>• See the "Connecting the Water Line" section.</li> <li>• The water pressure to the home affects the flow from the dispenser.</li> <li>• This can decrease water pressure. It is recommended not to connect the supply line to a reverse osmosis system for optimal operation.</li> <li>• The dispenser can be set for ice or water. Make certain that the control panel is set for the proper operation. Press the dispenser button on the control panel to cycle through the ice and water options.</li> </ul>



LG Customer Information Center

1-800-243-0000 USA, Consumer User  
1-888-865-3026 USA, Commercial User  
1-888-542-2623 CANADA

Register your Product Online!

[www.lg.com](http://www.lg.com)