

GALANZ GSWWD09S1A09A USER MANUAL



Quick Links

[Setting the Clock](#)

[Bake](#)

[Air Fry](#)

[Convection](#)

[Troubleshooting](#)

Table of Contents

[Table of Contents](#)

[Important Safety Instructions](#)

[Precautions to Avoid Possible Exposure to Excessive Microwave Energy](#)

[California Proposition 65 Warning](#)

[General Warning](#)

[Grounding Instructions](#)

[Installation Guide](#)

[Cooking Utensils Guide](#)

[Product Diagram](#)

[Control Panel](#)

[First Time Use](#)

[Product Specifications](#)

[Operation Instructions](#)

[Setting the Clock](#)

[Timer](#)

[Quick Start Microwave](#)

[Microwave Cooking](#)

[Weight Defrost](#)

[Time Defrost](#)

[Bake](#)

[Air Fry](#)

[Roast](#)

[Convection](#)

[Microwave+Convection](#)

[Auto Cook](#)

[Auto Reheat](#)

[Popcorn](#)

[+30 Sec Function](#)

[Child Lock](#)

[Troubleshooting](#)

Cleaning And Care

Product Warranty

Warranty Registration

Other ManualsLib Projects

Galanz

Model# GSWWD09S1A09A

User Manual

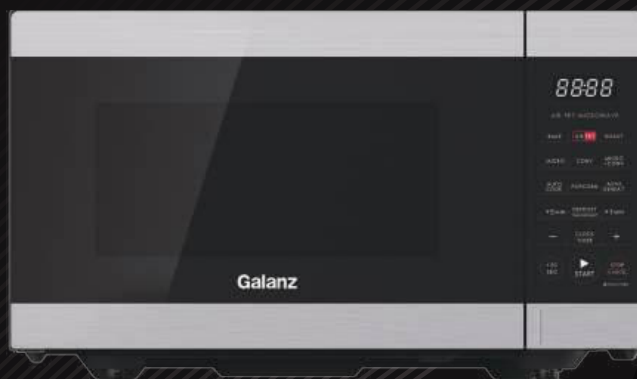

Thank you for purchasing a Galanz product. Please read this manual carefully for correct usage and safety, and keep for future reference. For service, support and warranty information, call 1-800-562-0738.

@2019 Galanz Americas Limited Company

CONTENTS

Important Safety Instructions.....	1
Precautions to Avoid Possible Exposure to Excessive Microwave Energy.....	1
California Proposition 65 Warning.....	1
General Warning	1
Grounding Instructions	3
Installation Guide.....	4
Cooking Utensils Guide	5
Product Diagram	6
Control Panel	7
First Time Use.....	8
Product Specifications	8
Operation Instructions	9
Setting the Clock.....	9
Timer	10
Quick Start Microwave.....	10
Microwave Cooking.....	11
Weight Defrost.....	12
Time Defrost	13
Bake	14
Air Fry.....	16
Roast.....	18
Convection.....	20
Microwave + Convection	21
Auto Cook.....	22
Auto Reheat	23
Popcorn	24
+30 Sec Function	24
Child Lock	25
Troubleshooting	26
Cleaning And Care	27
Product Warranty	28
Warranty Registration	29

IMPORTANT SAFETY INSTRUCTIONS

PRECAUTIONS TO AVOID POSSIBLE EXPOSURE TO EXCESSIVE MICROWAVE ENERGY

- Do not attempt to operate this oven with the door open since open-door operation can result in harmful exposure to microwave energy. It is important not to tamper with the safety interlocks.
- Do not place any object between the oven front face and the door or allow soil or cleaner residue to accumulate on sealing surfaces.
- Do not operate the oven if it is damaged. It is very important that the oven door closes properly and that there is no damage to the
 - a) Door (including any dent),
 - b) Hinges and latches (broken or loosened),
 - c) Door seals and sealing surfaces.The oven should not be adjusted or repaired by anyone except qualified service personnel.

CALIFORNIA PROPOSITION 65 WARNING

 CALIFORNIA RESIDENTS ONLY—
WARNING: This product can expose you to chemicals including styrene, which are known to the State of California to cause cancer, and bisphenol A (BPA), which are known to the State of California to cause birth defects or other reproductive harm. For more information go to www.P65Warnings.ca.gov

 SOLO RESIDENTES DE CALIFORNIA
ADVERTENCIA: Este producto puede exponerlo a productos químicos, incluido el estireno, que en el estado de California es cancerígeno, y al bisfenol A (BPA), que el estado de California considera que causan defectos de nacimiento u otros daños reproductivos. Para obtener más información, vaya a www.P65Warnings.ca.gov

WARNING

To reduce the risk of burns, electric shock, fire, injury to persons or exposure to excessive microwave energy:

- Read all instructions before using the appliance.
- Read and follow the specific "PRECAUTIONS TO AVOID POSSIBLE EXPOSURE TO EXCESSIVE MICROWAVE ENERGY" on page 1.
- This appliance must be grounded. Connect only to properly grounded outlet. See "GROUNDING INSTRUCTIONS " on page 3.
- Do not operate the oven when empty.
- Install or locate this appliance only in accordance with the provided installation instructions.
- Some products such as whole eggs and sealed containers -for example, closed glass jars- could explode and should not be heated in this oven.
- Use this appliance only for its intended use as described in this manual. Do not use corrosive chemicals or vapors in this appliance. This type of oven is specifically designed to heat, cook, or dry food. It is not designed for industrial or laboratory use.
- As with any appliance, close supervision is necessary when used by children.
- To reduce the risk of fire in the oven cavity:
 - Do not overcook food. Carefully attend appliance when paper, plastic, or other combustible materials are placed inside the oven to facilitate cooking.
 - Remove wire twist-ties from paper or plastic bags before placing bag in oven.
 - If materials inside the oven should ignite, keep oven door closed, turn oven off using the circuit breaker panel, and call

SAVE THESE INSTRUCTIONS

IMPORTANT SAFETY INSTRUCTIONS

emergency services.

- Do not use the cavity for storage purposes. Do not leave paper products, cooking utensils or food in the cavity when not in use.
- Liquids, such as water, coffee, or tea are able to be overheated beyond the boiling point without appearing to be boiling due to surface tension of the liquid. Visible bubbling or boiling when the container is removed from the microwave oven is not always present. This could result in very hot liquids suddenly boiling over when a spoon or other utensil is inserted into the liquid.
- To reduce the risk of injury to person:
 - Do not overheat the liquid.
 - Stir the liquid both before and halfway through heating it.
 - Do not use straight-sided containers with narrow necks.
 - After heating, allow the container to stand in the microwave oven for a short time before removing the container.
 - Use extreme care when inserting a spoon or other utensil into the container.
- Do not heat oil or fat for deep-frying. It is difficult to control the temperature of oil in a microwave oven.
- Do not cover or block any openings on the appliance.
- Do not operate this appliance if it has a damaged cord or a plug, if it is not working properly or if it has been damaged or dropped.
- Do not immerse cord or plug in water. Keep cord away from heated surface. Do not let cord hang over edge of table or counter.
- This appliance should be serviced only by qualified service personnel, contact nearest authorized service facility for examination, repair, or adjustment.
- When cleaning surfaces of door and oven that comes together on closing the door, use only mild, nonabrasive soaps, or

detergents applied with a sponge or soft cloth.

- Oversized food or oversized metal utensils should not be inserted in a microwave/toaster oven as they may create a fire or risk of electric shock.
- Do not store or use this appliance outdoors. Do not use this product near water, for example, near a kitchen sink, in a wet basement, near a swimming pool, or similar locations.
- Do not clean with metal scouring pads. Pieces can break off the pad and touch electrical parts involving a risk of electric shock.
- Do not store any materials, other than manufacturer's recommended accessories, in this oven when not in use.
- Do not cover turntables, pans or any other part of the oven with metal foil. This will cause overheating of the oven.
- This equipment has been tested and found to comply with Part 18 of the FCC Rules. Operation is subject to the following two conditions: (1) This device may not cause harmful interference, and (2) this device must accept any interference received, including interference that may cause undesired operation.

CAUTION: Changes or modifications not expressly approved by the party responsible for compliance could void the user's authority to operate the product.

This equipment generates, uses and can radiate radio frequency energy and, if not installed and used in accordance with the instructions, may cause harmful interference to radio communications. However, there is no guarantee that interference will not occur in a particular

SAVE THESE INSTRUCTIONS

IMPORTANT SAFETY INSTRUCTIONS

installation. If this equipment does cause harmful interference to radio or television reception, which can be determined by turning the equipment off and on, the user is encouraged to try to correct the interference by one or more of the following measures:

- Reorient or relocate the receiving antenna.
- Increase the separation between the equipment and receiver.
- Connect the equipment into an outlet on a circuit different from that to which the receiver is connected.
- Consult the dealer or an experienced radio/TV technician for help.

GROUNDING INSTRUCTIONS

This appliance must be grounded. In the event of an electrical short circuit, grounding reduces risk of electric shock by providing an escape wire for the electric current. This appliance is equipped with a cord having a grounding wire with a grounding plug. The plug must be plugged into an outlet that is properly installed and grounded.

Consult a qualified electrician or serviceman if the grounding instructions are not completely understood, or if doubt exists as to whether the appliance is properly grounded. If it is necessary to use an extension cord, use only a 3-wire extension cord that has a 3-blade grounding plug and a 3-slot receptacle that will accept the plug on the appliance. The marked rating of the extension cord should be equal to or greater than the electrical rating of the appliance.

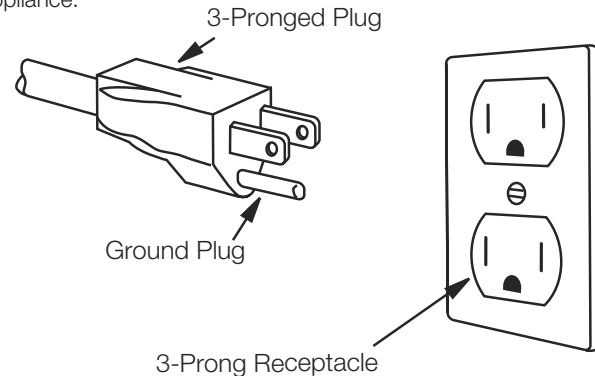

SAVE THESE INSTRUCTIONS

IMPORTANT SAFETY INSTRUCTIONS

Electrical Requirements

The electrical requirements are a 120 volt 60 Hz, AC only, 20 amp. It is recommended that a separate circuit serving only the oven be provided. The oven is equipped with a 3-prong grounding plug. It must be plugged into a wall outlet properly installed and grounded.

Power Cord

—A short power supply cord is provided to reduce the risks resulting from becoming entangled in or tripping over a longer cord.

—Longer cord sets or extension cords are available and may be used if care is exercised in their use.

—If long cord or extension cord is used:

- The marked electrical rating of the cord set or extension cord should be at least as great as the electrical rating of the appliance.
- The extension cord must be a grounding-type 3-wire cord, and the longer cord should be arranged so that it will not drape over the countertop or tabletop where it can be pulled on by children or tripped over accidentally.

INSTALLATION GUIDE

- Make sure that all the packing materials are removed from the inside of the door.
- This microwave oven must be placed on a flat, stable surface.
- For correct operation, the oven must have sufficient airflow. Allow minimum 8 inch (20.32cm) of free space necessary above the top surface of the oven and 2 inch (5.08cm) at both sides. Do not cover or block any openings on the appliance. Do not remove feet.
- The appliance should only be used on a countertop over 3 feet (91.44cm) above the floor.
- Do not place the oven where heat, moisture, or high humidity are generated, or near combustible materials.

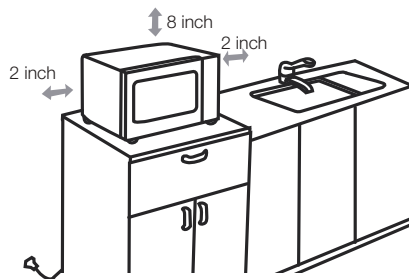

- Make sure that the power cord is undamaged and does not run under the oven or over any hot or sharp surface.
- The socket must be readily accessible so the microwave oven can be easily unplugged in an emergency.

SAVE THESE INSTRUCTIONS

IMPORTANT SAFETY INSTRUCTIONS

COOKING UTENSILS GUIDE



This section lists which utensils can be used in this microwave, which have limited use for short periods, and which should not be used in this microwave.

RECOMMENDED

Microwave browning dish — Use to brown the exterior of small items such as steaks, chops, or pancakes. Follow the directions provided with your browning dish.

Microwaveable plastic wrap — Use to retain steam. Leave a small opening for some steam to escape and avoid placing it directly on the food.

Paper towels and napkins — Use for short-term heating and covering; these absorb excess moisture and prevent spattering. Do not use recycled paper towels, which may contain metal and could ignite.

Glass and glass-ceramic bowls and dishes — Use for heating or cooking.

Paper plates and cups — Use for short-term heating at low temperatures. Do not use recycled paper, which may contain metal and could ignite.

Wax paper — Use as a cover to prevent spattering.

Thermometers — Use only those labeled "Microwave Safe" and follow all directions. Check the food in several places. Conventional thermometers may be used on microwave food once the food has been removed from the oven.

LIMITED USE

Aluminum foil — Use narrow strips of foil to prevent overcooking of exposed areas. Using too much foil can damage your oven, so be careful. You should keep distance of 1 inch (2.54cm) between aluminum foil and cavity.

Ceramic, porcelain, and stoneware — Use these if they are labeled "Microwave Safe". If they are not labeled, test them to make sure they can be used safely.

Plastic — Use only if labeled "Microwave Safe". Other plastics can melt.

NOT RECOMMENDED

Glass jars and bottles — Regular glass is too thin to be used in a microwave. It can shatter and cause damage and injury.

Paper bags — These are a fire hazard, except for popcorn bags.

Styrofoam plates and cups — These can melt and leave an unhealthy residue on food.

Plastic storage and food containers — Containers such as margarine tubs can melt in the microwave.

Metal utensils — These can damage your oven. Remove all metal before cooking.

Note:

Should you wish to check if a dish is safe for microwaving, place the empty dish in the oven and microwave at high power level for 30 seconds. A dish which becomes very hot should not be used.

SAVE THESE INSTRUCTIONS

PRODUCT DIAGRAM

1. Control Panel
2. Display Screen
3. Door Button
4. Oven Window
5. Top Heating Element
6. Upper Convection Fan
7. Glass Turntable
8. Roller Ring
9. Shaft
10. Baking and Roasting Pan
11. Air Fry Kit
12. Wave Guide (Please do not remove the mica plate covering the wave guide)
13. Door Safety Lock System

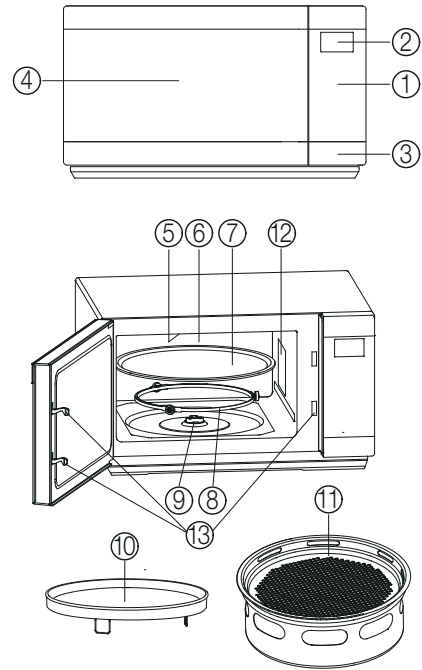

CONTROL PANEL



BAKE

Use to bake food (See Page 14).

AIR FRY

Use to air fry food (See Page 16).

ROAST

Use to roast food (See Page 18).

MICRO

Use to microwave food with selected power level (See Page 11).

CONV

Use to set convection program (See Page 20).

MICRO+CONV

Use to set combination cooking program (See Page 21).

AUTO COOK

Use to set automatic cooking programs (See Page 22).

POPCORN

Use to set popcorn program (See Page 24).

AUTO REHEAT

Use to set automatic reheating programs (See Page 23).

TIME / WEIGHT DEFROST

Press to set defrost program based on time (See Page 13).

Press to set defrost program based on weight (See Page 12).

+5MIN / +1MIN

Press to set the time of a cooking program.

CLOCK / TIMER

Press and hold to set the clock time (See Page 9).
Press to set the timer function (See Page 10).

- / +

Use to select cooking menus, time, food weight, portion, temperature and power level.

START

Press to start a cooking program.

+30 SEC

Press to add time (See Page 24).

STOP / CANCEL / CHILD LOCK

Press to clear all previous settings before cooking starts.

Press once to pause current cooking program or press twice to cancel the program.

Press and hold to set child lock (See Page 25).

FIRST TIME USE

If you are using your microwave for the first time, please be sure to:

- Clean the glass turntable, baking and roasting pan, air fry kit with hot water, a small amount of dishwashing liquid and a nonabrasive cleaning pad.
- Do not immerse the body of the unit in water.
- When you plug in the unit, the display will show "12:00".
- While you are in the process of any setting, the oven will return to standby mode after 30 seconds without any operation.
- During cooking, if press **STOP/CANCEL** once or open the door, the program will be paused. Press **START** to resume cooking, but if you press **STOP/CANCEL** twice, the program will be canceled.
- When the cooking completes, the screen will display "End" with sound every two minutes until you press **STOP/CANCEL** or open the door.

NOTE: During initial start up you may detect a slight smell and/or smoke. Use Convection function at 400 °F without food and let run for approximately 15 minutes.

Product Specifications

Power Supply	120V/60Hz
Power Consumption (Microwave)	1350W
Power Consumption (Convection)	1450W
Rated Microwave Power Output	900W
Operating Frequency	2450MHz
Outside Dimensions (W x H x D)	19 X 11 X 15 3/4 inch
Oven Cavity Dimensions (W x H x D)	13 1/2 X 8 3/4 X 13 1/2inch
Oven Capacity	0.9 Cu.Ft.
Net Weight	Approx. 35.49lbs

OPERATION INSTRUCTIONS

Setting the Clock



You can set the clock in 12-hour or 24-hour by pressing CLOCK/TIMER in standby mode.

Example: How to set a 12-hour clock at 11:58.

1 In standby mode, press and hold CLOCK/TIMER for 3 seconds to select 12-hour clock (press the pad again to select 24-hour clock).	

2 Press +/- until the correct hour is displayed.	
or	

3 Press START or CLOCK/TIMER to confirm the hour.	
or	

4 Press +/- until the correct minute is displayed.	
or	

5 Press START or CLOCK/TIMER to confirm the minute and finish setting.	
or	

NOTE: While in the process of setting the clock, you can cancel the settings by pressing the STOP/CANCEL.

OPERATION INSTRUCTIONS

Timer



You can use the timer feature to count down a specific amount of time whether it's for cooking or for anything else.

Example: How to set the timer for 3 minutes and 50 seconds.

1 Press CLOCK/TIMER once.	
2 Press +/- to enter the time. The maximum time you can set is 95 minutes.	
or	
3 Press START to confirm and start countdown.	

NOTE: Timer countdown can be seen for 5 seconds by touching **CLOCK/TIMER**, if press **STOP/CANCEL** during these 5 seconds, the timer will be canceled.

Quick Start Microwave



Accessory Guide: Glass Turntable



This feature allows you to start the oven quickly at maximum microwave power. The longest cooking time is 95 minutes.

Example: How to quick start microwave for 3 minutes and 50 seconds.

1 In stand-by mode, press +/- +1MIN / +5MIN to enter the time.	
2 Press START to confirm and start cooking.	

OPERATION INSTRUCTIONS

Microwave Cooking



Accessory Guide: Glass Turntable



This feature allows you to choose the power level and cooking time of microwave function. The longest cooking time is 95 minutes.

Example: Cook at 30% power level for 3 minutes and 50 seconds.

1 Press MICRO pad once, the default power level is 100%(maximum power).

MICRO

8:00

2 Press +/- to select the 30% power level.

- or +

8:30

3 Press START once to confirm the power level.

START

8:00

4 Press +/- / +1MIN / +5MIN to enter cooking time

- + +1MIN +5MIN

8:50

5 press START to confirm and start cooking.

START

8:50

Power Level Chart:

Power Level	Display	Power Level	Display
100%	P100	40%	P 40
90%	P-90	30%	P 30
80%	P-80	20%	P 20
70%	P-70	10%	P 10
60%	P-60	0%	P 00
50%	P-50		

OPERATION INSTRUCTIONS

Weight Defrost

Accessory Guide: Glass Turntable



The defrosting time and power level are automatically set once the food category and the weight are selected.



Example: How to defrost 8oz seafood.

1 In standby mode, press the TIME/WEIGHT DEFROST twice.

 x 2



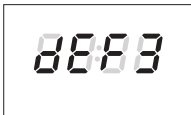

2 Press +/- to select food code 'dEF3' (Seafood).

 or 





3 Press START once to confirm the food type.





4 Press +/- to select the food weight.

 or 



5 Press START to confirm and start defrosting.





Weight Defrost Food Chart:

Food	Code	Maximum Weight
Meat	dEF1	80oz
Poultry	dEF2	80oz
Seafood	dEF3	32oz

NOTE:

During the defrosting program, the system will pause and alert the user to turn the food over when 1/3 of the defrosting time remains. After turning food over, close the door and press START to resume the defrosting.

OPERATION INSTRUCTIONS

Weight must be in pounds and ounces. If label gives weight in pounds only, change the fraction of a pound to ounces using the following chart.

Converting fractions of a pound to ounces:

Fractions of a pound	Ounces	Fractions of a pound	Ounces
Less than .03	0	.54 to .59	9
.03 to .09	1	.60 to .65	10
.10 to .15	2	.66 to .71	11
.16 to .21	3	.72 to .78	12
.22 to .27	4	.79 to .84	13
.28 to .34	5	.85 to .90	14
.35 to .40	6	.91 to .97	15
.41 to .46	7	.97 to .99	16
.47 to .53	8		

Time Defrost



Accessory Guide: Glass Turntable



The defrosting power is adjusted automatically once the cooking time is programmed.

Example: How to defrost food for 3 minutes and 50 seconds.

1 In standby mode, press the TIME/WEIGHT DEFROST once.	
2 Press +/- / +1MIN / +5MIN to select the defrosting time.	
3 Press START to confirm and start defrosting.	

NOTE:

During the defrosting program, the system will pause and alert the user to turn the food over when 1/3 of the defrosting time remains. After turning food over, close the door and press START to resume the defrosting.

OPERATION INSTRUCTIONS

Bake



Accessory Guide: Glass Turntable Baking and Roasting Pan



For Bake, you can select the type of food you want to cook from the programs listed on the cooking label located on the interior panel of the appliance.

Auto Program: How to bake a 9 inch round pan cake.

- 1** In standby mode, press the BAKE twice to use auto program.

BAKE x2

88:88

- 2** Press + / - to select food code 'Ab-2' (Cake).

- or +

88:82

- 3** Press START once to confirm and start preheating.



350F

- 4** When preheating finishes, the oven will show 'Add Food 350F' and sound periodically to remind user to put the food inside.

88:88 → 88:88 → 350F

350F

- 5** Open the oven door, the display will show the cooking time, and then place food into the oven. Close the oven door.

16:00

- 6** Press START once to confirm and start cooking.













16:00

Bake Food Chart (Auto Program):

Food	Code	Portion	Preheating Temperature	Cooking Time
Cookies	Ab-1	7 Cookies	350°F	11:00
Cake	Ab-2	9 inch round pan	350°F	16:00

OPERATION INSTRUCTIONS

Custom Program: How to set Bake by choosing time and temperature (400°F for 25 minutes).

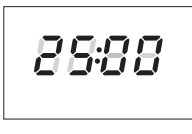
1 In standby mode, press the BAKE once to use custom setting (Default is 350 °F).		
2 Press +/- to select temperature.	 or 	
3 Press START once to confirm the temperature.		
4 Press +/- / +1MIN / +5MIN to enter cooking time	   	

5 Press START once to confirm and start preheating.		
6 When preheating finishes, the oven will show 'Add Food 400F' and sound periodically to remind user to put the food inside.		
7 Open the oven door, the display will show the cooking time, and then place food into the oven. Close the oven door.		
8 Press START once to confirm and start cooking.		

NOTE:

- It can be programmed for four different temperatures.
They are: 350°F(default) → 375°F → 400°F → 300°F. → 325°F.
- The longest cooking time is 95 minutes.

OPERATION INSTRUCTIONS

Air Fry



Accessory Guide: Glass Turntable

Air Fry Kit



For Air Fry cooking, you can select the type of food you want to cook from the programs listed on the cooking label located on the interior panel of the appliance.

Auto Program: How to air fry 16oz chicken wings.

1 In standby mode, press the AIR FRY twice to use auto program.

AIR FRY x 2

88:88

2 Press +/- to select food code 'AF-3' (Chicken Wings).

- or +

88:88

3 Press START once to confirm food code.



88:00

4 Press +/- to select food weight.

- or +

88:00

5 Press START once to confirm and start cooking.















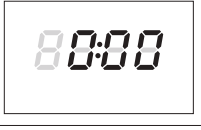

34:00

OPERATION INSTRUCTIONS

Air Fry Food Chart (Auto Program):

Food	Code	Weight	Cooking Time
Chicken Drumsticks	AF-1	8 oz	30:00
		12 oz	33:00
		16 oz	36:00
		20 oz	39:00
		24 oz	42:00
Chicken Nuggets	AF-2	6 oz	13:00
		8 oz	15:00
		10 oz	19:00
		12 oz	23:00
Chicken Wings	AF-3	8 oz	30:00
		12 oz	32:00
		16 oz	34:00
		20 oz	36:00
French Fries	AF-4	10 oz	30:00
Mozzarella Sticks	AF-5	6 oz	10:00
		8 oz	11:00
		10 oz	12:00
		12 oz	13:00
		14 oz	14:00
		16 oz	15:00
Onion Rings	AF-6	8 oz	17:00
Popcorn Chicken	AF-7	8 oz	22:00
		10 oz	24:00
		12 oz	26:00
		16 oz	28:00

Custom Program: How to set AirFry by choosing time and temperature (350°F for 30 minutes).

- In standby mode, press the AIR FRY once to use custom setting (Default is 400°F).
 

- Press + / - to select the temperature 350°F.
  or 

- Press START once to confirm the temperature.
 

- Press + / - / +1MIN / +5MIN to set cooking time.
    

- Press START to confirm and start cooking.
 

NOTE:

- It can be programmed for three different temperatures. They are: 400°F(default) → 350°F → 375°F.
- The longest cooking time is 95 minutes.

OPERATION INSTRUCTIONS

Roast



Accessory Guide: Glass Turntable Baking and Roasting Pan



For Roast cooking, you can select the type of food you want to cook from the programs listed on the cooking label located on the interior panel of the appliance.

Auto Program: How to Roast 12oz roasted potatoes.

1 In standby mode, press the ROAST twice to use auto program.

ROAST x 2

88:88

2 Press + / - to select food code 'Ar-4' (Roasted Potatoes).

- or +

88:83

3 Press START once to confirm food code.

START

88:83

4 Press + / - to select food weight.

- or +

88:00

5 Press START once to confirm and start cooking.

START

88:00



Roast Food Chart (Auto Program):

Food	Code	Weight	Cooking Time
Pork Loin	Ar-1	2 Lb	35:00
		3 Lb	45:00
Pork Tenderloin	Ar-2	1 Lb	22:00
		2 Lb	34:00
Roasted Potatoes	Ar-3	4 oz	36:00
		6 oz	38:00
		8 oz	40:00
		10 oz	42:00
		12 oz	44:00
		16 oz	46:00
Salmon Filet	Ar-4	4 oz	25:00
		8 oz	28:00
		12 oz	31:00
		16 oz	34:00
		20 oz	37:00

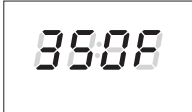

OPERATION INSTRUCTIONS

Custom Program: How to set Roast by choosing time and temperature (400°F for 25 minutes).



1 In standby mode, press the ROAST once to use custom setting (Default is 350 °F).



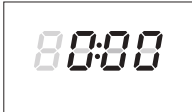

2 Press + / - to select temperature 400 °F.

 or 



3 Press START once to confirm the temperature.

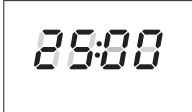

4 Press + / - to select cooking time.

 or 

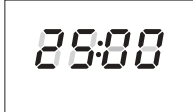
5 Press START once to confirm and start cooking.



NOTE:

- It can be programmed for four different temperatures. They are: 350°F(default) → 375°F → 400°F → 325°F.
- The longest cooking time is 95 minutes.

OPERATION INSTRUCTIONS













Convection



Accessory Guide: Glass Turntable Baking and Roasting Pan





This feature allows you cook with powerful convection. During convection cooking, hot air is circulated throughout the oven cavity to brown and crisp foods quickly and evenly.



Example: How to cook with convection temperature 400°F for 25 minutes.

1 In standby mode, press the CONV pad once to use custom setting (Default is 350°F.	
	
2 Press + / - to select the preheating and cooking temperature.	
 or 	
3 Press START once to confirm the temperature.	
	
4 Press + / - / +1MIN / +5MIN to enter cooking time.	
   	

5 Press START once to confirm the cooking time and start preheating.	
	

6 When preheating finishes, the oven will show 'Add Food 400F' and sound periodically to remind user to put the food inside.	
	

7 Open the oven door, the display will show the cooking time, and then place food into the oven. Close the oven door.	
--	---

8 Press START once to confirm and start cooking.	
	

NOTE:

- It can be programmed for 10 different temperatures. They are: 350°F(default) → 375°F → 400°F → 175°F → 200°F → 225°F → 250°F → 275°F → 300°F → 325°F .
- The longest cooking time is 95 minutes.

OPERATION INSTRUCTIONS

Microwave+Convection



Accessory Guide: Glass Turntable Baking and Roasting Pan



This oven has five pre-programmed temperatures settings that make it easy to cook with both convection heat and microwave automatically. They are: 350°F→375°F→400°F→300°F→325°F. The longest time is 95 minutes.

Example: How to set the combination of microwave and convection at temperature 400°F for 30 minutes.

1 In standby mode, press MICRO+CONV once to use custom setting (Default is 350°F).	

2 Press + / - to select the temperature.	
or	

3 Press START once to confirm the temperature.	

4 Press + / - / +1MIN / +5MIN to select cooking time.	

5 Press START to confirm and start cooking.	

NOTE: You can check the convection temperature during cooking by pressing the MICRO+CONV.

OPERATION INSTRUCTIONS

Auto Cook

Accessory Guide: Glass Turntable



For auto cook function, you can select the type of food you want to cook from the programs listed on the cooking label located on the interior panel of the appliance.

Auto Program: How to Cook 8oz fresh vegetables.

1 In standby mode, press the AUTO COOK once.



80:00

2 Press + / - to select food code 'AC-3' (Fresh Vegetable).

-

or

+

80:03

3 Press START once to confirm the food type.



80:03

4 After selecting the food type, press + / - to select portion of food.

-

or

+

88:00

5 Press START to start cooking.



88:30

Auto Cook Food Chart (Auto Program):

Code	Food	Weight
AC-1	Beverage	8-12 oz
AC-2	Frozen Pizza	6-12 oz
AC-3	Fresh Vegetable	8-20 oz
AC-4	Frozen Vegetable	8-20 oz
AC-5	Oatmeal	1-4 packs
AC-6	Potato	8-24 oz

OPERATION INSTRUCTIONS

Auto Reheat

Accessory Guide: : Glass Turntable





For auto reheat function, you can select the type of food you want to cook from the programs listed on the cooking label located on the interior panel of the appliance.

Auto Program: How to Reheat soup.

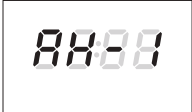
1 In standby mode, press the AUTO REHEAT once.

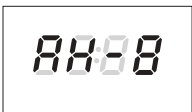

2 Press +/- to select food code 'AH-3' (Soup).

 or 

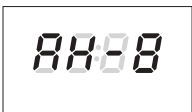

3 Press START once to confirm the food type.

4 After selecting the food type, press +/- to select portion of food.

 or 

4 Press START to start cooking.

Auto Reheat Food Chart (Auto Program):

Code	Food	Weight
AH-1	Chili	4-24 oz
AH-2	Dinner Plate	8-24 oz
AH-3	Frozen Entrée	8-24 oz
AH-4	Mac and Cheese	4-24 oz
AH-5	Mashed Potatoes	4-24 oz
AH-6	Pasta	4-24 oz
AH-7	Rice	4-28 oz
AH-8	Soup/ Sauce	4-24 oz



OPERATION INSTRUCTIONS



Popcorn

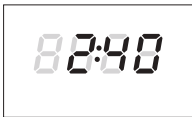

Accessory Guide: Glass Turntable



Example: How to cook popcorn for 3 minutes and 30 seconds.

1 In standby mode, press the POPCORN. The default time is 2 minutes and 40 seconds (For one bag around 3.5 oz).	
	

2 Press + / - to select the cooking time.	
 or 	

3 Press START once to confirm and start cooking.	
	



NOTE:
The default time is 2 minutes and 30 seconds. For default time, you can skip step 2, directly press the dial to start if you prefer.

+30 Sec Function

In standby mode, press +30 SEC, the microwave program will start at 100% power level and cook for 30 seconds. During cooking, you can add cooking time by touching +30 SEC pad repeatedly. The longest cooking time is 95 minutes.

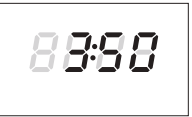
Example: During microwave cooking, add the cooking time by 2 minutes by utilizing the +30 SEC button.

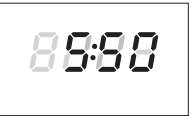
1 During cooking, suppose the display is showing 3:50.	

2 Press the +30 SEC 4 times.	
 x 4	

NOTE:
■ All preset programs cannot use +30 SEC during cooking, which includes:

- POPCORN
- TIME / WEIGHT DEFROST
- **AUTO COOK**
- **AUTO REHEAT**

OPERATION INSTRUCTIONS

Child lock



The child proof lock prevents unsupervised operation by children.

Example1: How to set/cancel the child lock.

1 In standby mode, suppose the display is showing 11:58.	

2 Press and hold STOP/CANCEL for 3 seconds, then 'LOC' appears.	
Press and hold for 3 seconds.	

3 Press and hold STOP/CANCEL for 3 seconds, then 'LOC' disappears.	
Press and hold for 3 seconds.	

TROUBLE SHOOTING

Automatic Protection Mechanism



LOW TEMPERATURE PROTECTION - The display may show Er03 which means the appliance has entered into low temperature protection mode which will protect the appliance from further damage. Audible alert will be heard until STOP/CANCEL is pressed or the appliance is unplugged.

OVERHEATING PROTECTION - The display may show Er04 which means the appliance has entered into high temperature overheat mode which will protect the appliance from further damage. Audible alert will be heard until STOP/CANCEL is pressed or the appliance is unplugged.

CIRCUIT PROTECTION - The display may show Er05 which means the appliance's thermostats are under open circuit protection which will protect the appliance from further damage. Audible alert will be heard until STOP/CANCEL is pressed or the appliance is unplugged.

CIRCUIT PROTECTION - The display may show Er06 which means the appliance's thermostats are under short circuit protection which will protect the appliance from further damage. Audible alert will be heard until STOP/CANCEL is pressed or the appliance is unplugged.

- Turn off the oven and unplug the power cord from the wall when cleaning.

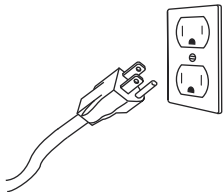

- Keep the inside of the oven clean. When food splatters or spilled liquids adhere to oven walls, wipe with a damp cloth. Mild detergents may be used if the oven gets very dirty. Avoid using spray or other harsh cleaners. They may stain, streak or dull the door surface.



- The outside of the oven should be cleaned with a damp cloth. To prevent damage to the operating parts inside the oven, water should not be allowed to seep into the ventilation openings.
- Wipe the door and window on both sides, the door seals and adjacent parts frequently with a damp cloth to remove any spills or splatters. Do not use abrasive cleaner.
- Do not allow the control panel to become wet. Clean with a soft, damp cloth. When cleaning the control panel, leave oven door open to prevent oven from accidentally turning on.

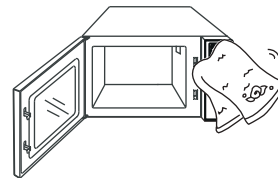

- If steam accumulates inside or around the outside of the oven door, wipe with a soft cloth. This may occur when the microwave oven is operated under high humidity conditions. It is normal.
- It is occasionally necessary to remove the glass turntable, baking and roasting pan, air fry kit for cleaning. Wash them in warm sudsy water.

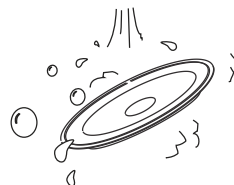

- If the light bulb burns out, please contact customer service to have it replaced.
- The oven should be cleaned regularly and any food deposits should be removed. Failure to maintain the oven in a clean condition could lead to deterioration of surface that could adversely affect the life of the unit and could possibly result in a hazardous situation.
- Please do not dispose of this appliance into normal trash bins; it should be disposed through local municipalities disposal centers.

This warranty applies to products sold by Galanz Americas in the U.S. This warranty is in lieu of any other warranty and expressly applies to the individual product only.

Galanz product is warranted for one year following purchase for defects in material and workmanship. **Please save your receipt as proof of purchase is required to make a warranty claim.** During this period, we will provide the replacement cost of this product, a replacement or the equivalent, or repair per our discretion.

The warranty can not be transferred through resale, including the resale through a 3rd party unauthorized retailer and is only bestowed upon the original consumer purchaser upon purchase from an authorized retailer.

■ **This warranty does not cover and excludes damage or defects caused by:**

- Consumer misuse
- Abuse
- Neglect including the failure to clean and/or provide adequate regular maintenance as outlined in the user manual
- Commercial use
- Subjecting the product to any voltage outside the specified range
- Loss of parts
- The affixing of any attachments not provided with the product
- Accident
- Use in a manner not intended and outlined in the user manual.

■ Any subsequent damages caused by the above listed exclusions will not be covered and any claims determined to meet the above exclusions will be denied. All liability is limited to the purchase price and does not include any:

- Retail offered extended warranties
- Tax
- Other charges (including postage to send required materials)
- Incidental and/or consequential damages associated with the product in question.

Every implied warranty, including any statutory warranty of merchantability or fitness for a particular purpose is disclaimed except to the extent prohibited by law, in which case such warranty is limited to the duration of this written warranty. This warranty gives you specific legal rights. You may have other legal rights that vary depending on where you live. Some states do not allow limitations on implied warranties or special, incidental, or consequential damaged, so the above limitations may not apply to you.

If you have a claim under this warranty, please call our Customer Service number: 1-800-562-0738.

For faster service, please have the model number (from rating label), serial number (rear of the cavity), and receipt ready for the operator to assist you.

Please mail this warranty card to the address below within 30 days of purchase.
Galanz Americas, 55 Challenger Road, Suite 503, Ridgefield Park, NJ 07660.

PLEASE PRINT CLEARLY.

Name _____

Address _____

City _____ State _____ ZIP _____

Phone _____ Email _____

Model Number _____ Serial Number _____

Purchase Location _____

You must attach a copy of your purchase receipt to validate your registration.

Galanz

Other ManualsLib Projects



www.manualslib.com



www.manualslib.de



www.manualslib.es



www.manualslib.fr



www.manualslib.nl



www.manualslib.mx



www.manualslib.tech 30+ Languages