



### History-Based Value Report

## History events affecting this vehicle's value



**Service History**



**Personal Vehicle**



**Accident Reported**

**\$29,300 Retail Value**



### Vehicle History Report™

**2011 CHEVROLET CORVETTE**

VIN: 1G1YG3DW2B5106396  
 CONVERTIBLE  
 6.2L V8 F OHV 16V  
 GASOLINE  
 REAR WHEEL DRIVE

**Accident reported: moderate damage**

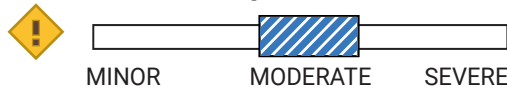

**16** Service history records

**3** Previous owners

Personal vehicle

**62,514** Last reported odometer reading

This CARFAX Vehicle History Report is based only on information supplied to CARFAX and available as of 12/15/22 at 5:34:42 PM (CST). Other information about this vehicle, including problems, may not have been reported to CARFAX. Use this report as one important tool, along with a vehicle inspection and test drive, to make a better decision about your next used car.





### Ownership History

The number of owners is estimated

	Owner 1	Owner 2	Owner 3
Year purchased	2011	2013	2015
Type of owner	Personal	Personal	Personal
Estimated length of ownership	1 yr. 6 mo.	2 years	7 yrs. 1 mo.

Owned in the following states/provinces	Virginia	Florida, South Dakota	South Dakota, New Mexico
Estimated miles driven per year	6,747/yr	8,724/yr	5,275/yr
Last reported odometer reading	10,901	28,940	62,514

 <b>Title History</b> CARFAX guarantees the information in this section	Owner 1	Owner 2	Owner 3
<b>Damage Brands</b> Salvage   Junk   Rebuilt   Fire   Flood   Hail   Lemon	<input checked="" type="checkbox"/> <b>Guaranteed</b> No Problem	<input checked="" type="checkbox"/> <b>Guaranteed</b> No Problem	<input checked="" type="checkbox"/> <b>Guaranteed</b> No Problem
<b>Odometer Brands</b> Not Actual Mileage   Exceeds Mechanical Limits	<input checked="" type="checkbox"/> <b>Guaranteed</b> No Problem	<input checked="" type="checkbox"/> <b>Guaranteed</b> No Problem	<input checked="" type="checkbox"/> <b>Guaranteed</b> No Problem

 **GUARANTEED** - None of these major title problems were reported by a state Department of Motor Vehicles (DMV). If you find that any of these title problems were reported by a DMV and not included in this report, CARFAX will buy this vehicle back.  
View Terms | View Certificate

 <b>Additional History</b> Not all accidents / issues are reported to CARFAX	Owner 1	Owner 2	Owner 3
<b>Total Loss</b> No total loss reported to CARFAX.	<input checked="" type="checkbox"/> No Issues Reported	<input checked="" type="checkbox"/> No Issues Reported	<input checked="" type="checkbox"/> No Issues Reported
<b>Structural Damage</b> CARFAX recommends that you have this vehicle inspected by a collision repair specialist.	<input checked="" type="checkbox"/> No Issues Reported	<input checked="" type="checkbox"/> No Issues Reported	<input checked="" type="checkbox"/> No Issues Reported
<b>Airbag Deployment</b> No airbag deployment reported to CARFAX.	<input checked="" type="checkbox"/> No Issues Reported	<input checked="" type="checkbox"/> No Issues Reported	<input checked="" type="checkbox"/> No Issues Reported
<b>Odometer Check</b> No indication of an odometer rollback.	<input checked="" type="checkbox"/> No Issues Indicated	<input checked="" type="checkbox"/> No Issues Indicated	<input checked="" type="checkbox"/> No Issues Indicated
<b>Accident / Damage</b> Accidents reported: 02/03/2016 and 12/19/2016. Damage reported: 02/16/2017.	<input checked="" type="checkbox"/> No Issues Reported	<input checked="" type="checkbox"/> No Issues Reported	Accident Reported
<b>Manufacturer Recall</b> No open recalls reported to CARFAX. Check for open recalls on GM vehicles at recalls.gm.com.	<input checked="" type="checkbox"/> No Recalls Reported	<input checked="" type="checkbox"/> No Recalls Reported	<input checked="" type="checkbox"/> No Recalls Reported
<b>Basic Warranty</b> Original warranty estimated to have expired.	<b>Warranty Expired</b>	<b>Warranty Expired</b>	<b>Warranty Expired</b>



## Detailed History



**Owner 1**  
Purchased: 2011



**Low mileage!** This owner drove less than the industry average of 15,000 miles per year.



Personal Vehicle  
6,747 mi/yr

Date	Mileage	Source	Comments
12/22/2010		Southern Pines Chevrolet Buick Pontiac Southern Pines, NC 910-692-2002  ★ 4.6 / 5.0 321 Verified Reviews ♥ 4,00 Customer 4 Favorites	<b>Vehicle offered for sale</b>
01/04/2011	7	Southern Pines Chevrolet Buick GMC Southern Pines, NC 910-692-2002  ★ 4.6 / 5.0 321 Verified Reviews ♥ 4,00 Customer 4 Favorites	<b>Vehicle serviced</b> - Pre-delivery inspection completed - Safety inspection performed
06/27/2011	23	Southern Pines Chevrolet Buick GMC Southern Pines, NC 910-692-2002  ★ 4.6 / 5.0 321 Verified Reviews ♥ 4,00 Customer 4 Favorites	<b>Vehicle serviced</b> - Body computer/module replaced - Computer module replaced - Engine/powertrain computer/module replaced - Body electrical system checked
08/11/2011		Southern Pines Chevrolet Buick GMC Southern Pines, NC 910-692-2002  ★ 4.6 / 5.0 321 Verified Reviews ♥ 4,00 Customer 4 Favorites	<b>Vehicle serviced</b> - Battery/charging system checked - Emissions inspection performed
08/30/2011	253	Virginia Motor Vehicle Dept.	<b>Vehicle purchase reported</b> - Titled or registered as personal vehicle
09/09/2011		Virginia Motor Vehicle Dept. Blacksburg, VA	<b>Registration issued or renewed</b> - Title or registration issued - First owner reported - Loan or lien reported

08/14/2012	9,733	Virginia Inspection Station	<b>Passed safety inspection</b>
08/15/2012		Virginia Motor Vehicle Dept. Blacksburg, VA	<b>Registration issued or renewed</b> - Loan or lien reported
01/10/2013		Price's Service Center Blacksburg, VA 540-552-5041 1 Customer Favorite	<b>Vehicle serviced</b> - Emissions or safety inspection performed
03/14/2013	10,642	Duncan Ford Lincoln Mazda Christiansburg, VA 540-552-4331 4.6 / 5.0 134 Verified Reviews 132 Customer Favorites	<b>Vehicle offered for sale</b>
03/21/2013	10,901	Dealer Inventory	<b>Vehicle offered for sale</b>

<b>Owner 2</b> Purchased: 2013 	<div style="border: 1px solid blue; padding: 5px;"> <b>Low mileage!</b> This owner drove less than the industry average of 15,000 miles per year.         </div>	Personal Vehicle 8,724 mi/yr
---------------------------------------	--	---------------------------------

Date	Mileage	Source	Comments
03/28/2013	10,915	Florida Motor Vehicle Dept.	<b>Vehicle purchase reported</b>
04/22/2013		Florida Motor Vehicle Dept. Palm Harbor, FL Title #0111614283	<b>Title issued or updated</b> - Registration issued or renewed - New owner reported - Titled or registered as personal vehicle - Loan or lien reported - Vehicle color noted as Maroon
11/18/2013	19,601	Dimmitt Chevrolet Clearwater, FL 727-791-1818 4.3 / 5.0 277 Verified Reviews 251 Customer Favorites	<b>Vehicle serviced</b> - Maintenance inspection completed
12/12/2013	19,683	Dimmitt Chevrolet Clearwater, FL 727-791-1818 4.3 / 5.0 277 Verified Reviews 251 Customer Favorites	<b>Vehicle serviced</b> - Maintenance inspection completed

02/03/2014		Florida Motor Vehicle Dept. Palm Harbor, FL Title #0111614283		<b>Registration issued or renewed</b> - Titled or registered as personal vehicle - Loan or lien reported - Vehicle color noted as Maroon
06/05/2014	22,374	Valley River Chevrolet Murphy, NC 828-682-8721 ★ 4.6 / 5.0 17 Verified Reviews ❤️ 421 Customer Favorites		<b>Vehicle serviced</b> - Maintenance inspection completed
08/29/2014	25,486	Valley River Chevrolet Murphy, NC 828-682-8721 ★ 4.6 / 5.0 17 Verified Reviews ❤️ 421 Customer Favorites		<b>Vehicle serviced</b> - Maintenance inspection completed
02/11/2015		Florida Motor Vehicle Dept. Palm Harbor, FL Title #0111614283		<b>Registration issued or renewed</b> - Titled or registered as personal vehicle - Loan or lien reported - Vehicle color noted as Maroon
04/16/2015		Florida Motor Vehicle Dept. Palm Harbor, FL Title #0111614283		<b>Registration issued or renewed</b> - Titled or registered as personal vehicle - Vehicle color noted as Maroon
04/21/2015	28,938	Dealer Inventory		<b>Vehicle offered for sale</b>
06/23/2015	28,940	South Dakota Motor Vehicle Dept. Beresford, SD Title #151700663		<b>Title issued or updated</b> - Dealer took title of this vehicle while it was in inventory - Vehicle color noted as Red



**Owner 3**  
Purchased: 2015



**Low mileage!** This owner drove less than the industry average of 15,000 miles per year.

Personal Vehicle  
5,275 mi/yr

Date	Mileage	Source	Comments
11/13/2015	28,952	South Dakota Motor Vehicle Dept. Sioux Falls, SD Title #152751198	<b>Title issued or updated</b> - Registration issued or renewed - New owner reported - Vehicle color noted as Red
02/03/2016		Damage Report	 <b>Accident reported: moderate damage with another motor vehicle</b> - Damage to right rear - Damage to right side - Airbags did not deploy

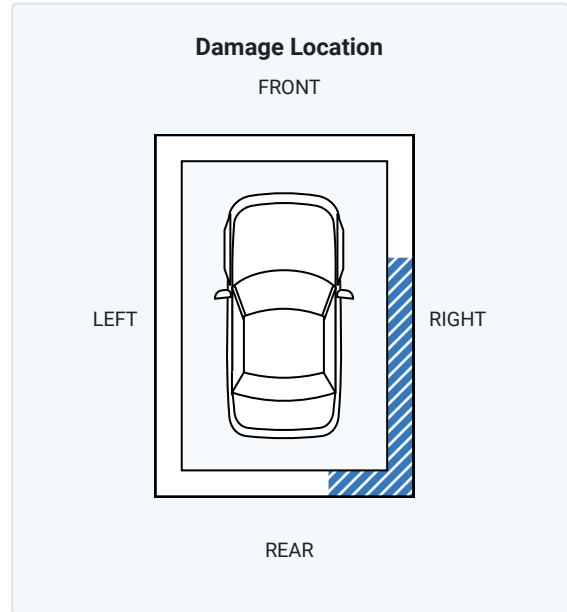
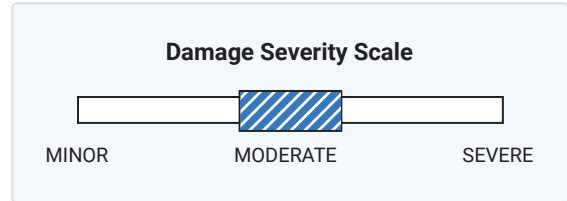

12/19/2016

Damage Report



**Accident reported: minor damage with another motor vehicle**

- Damage to right rear
- Damage to right side
- Airbags did not deploy

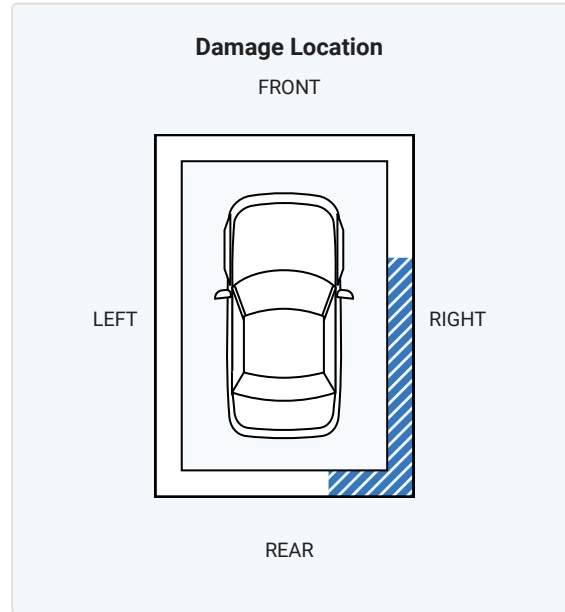
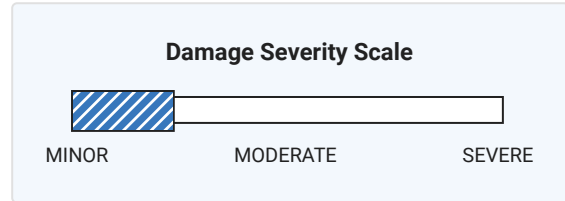

12/30/2016

South Dakota  
Motor Vehicle Dept.  
Sioux Falls, SD

**Registration issued or renewed**  
- Vehicle color noted as Red

02/16/2017

Damage Report



**Damage reported: very minor damage**  
- Damage to right rear

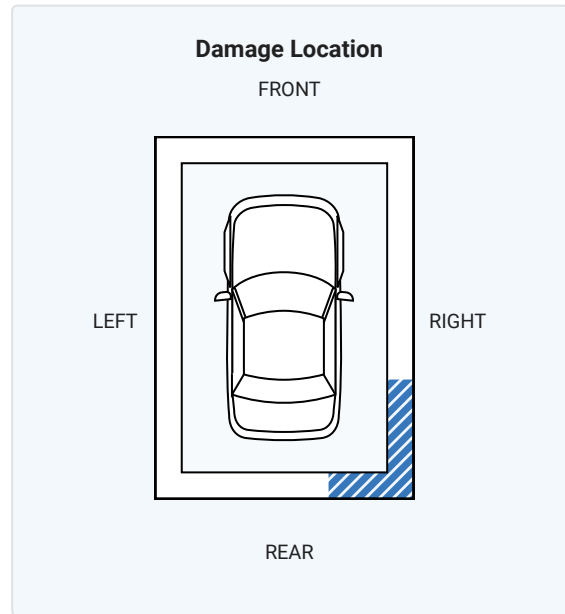
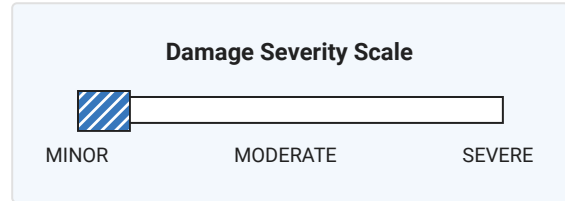

07/03/2017 37,556

Sisbarro Buick GMC  
Las Cruces, NM  
575-524-7707

★ 4.6 / 5.0  
108 Verified Reviews  
♥ 1,00 Customer  
0 Favorites



**Vehicle serviced**  
- Oil and filter changed

01/25/2018 37,877

New Mexico  
Motor Vehicle Dept.  
Las Cruces, NM  
Title #1802507C1906852

**Vehicle purchase reported**  
- Title or registration issued  
- Registration updated when owner moved the vehicle to a new location  
- Vehicle color noted as Red

04/25/2018 39,019

Sisbarro Buick GMC  
Las Cruces, NM  
575-524-7707

★ 4.6 / 5.0  
108 Verified Reviews  
♥ 1,00 Customer  
0 Favorites



**Vehicle serviced**  
- Maintenance inspection completed  
- Tire condition and pressure checked  
- Tire(s) balanced

10/01/2018 44,189





Sisbarro Buick GMC  
Las Cruces, NM  
575-524-7707

★ 4.6 / 5.0  
108 Verified Reviews  
♥ 1,00 Customer  
0 Favorites



**Vehicle serviced**  
- Maintenance inspection completed  
- Oil and filter changed



01/07/2020		New Mexico Motor Vehicle Dept. Las Cruces, NM Title #1802507C1906852		<b>Registration issued or renewed</b> - Vehicle color noted as Red
04/09/2020	53,788	Sisbarro Buick GMC Las Cruces, NM 575-524-7707 ★ 4.6 / 5.0 108 Verified Reviews ❤️ 1,000 Customer Favorites		<b>Vehicle serviced</b> - Maintenance inspection completed - Oil and filter changed
09/29/2020	54,891	Sisbarro Buick GMC Las Cruces, NM 575-524-7707 ★ 4.6 / 5.0 108 Verified Reviews ❤️ 1,000 Customer Favorites		<b>Vehicle serviced</b>
10/30/2020		Sisbarro Buick GMC Las Cruces, NM 575-524-7707 ★ 4.6 / 5.0 108 Verified Reviews ❤️ 1,000 Customer Favorites		<b>Vehicle serviced</b> - Electrical system checked
02/20/2021	56,099	Sisbarro Buick GMC Las Cruces, NM 575-524-7707 ★ 4.6 / 5.0 108 Verified Reviews ❤️ 1,000 Customer Favorites		<b>Vehicle serviced</b> - Maintenance inspection completed - Tire condition and pressure checked
01/05/2022		New Mexico Motor Vehicle Dept. Las Cruces, NM Title #1802507C1906852		<b>Registration issued or renewed</b> - Vehicle color noted as Red
03/23/2022	62,514	Sisbarro Buick GMC Las Cruces, NM 575-524-7707 ★ 4.6 / 5.0 108 Verified Reviews ❤️ 1,000 Customer Favorites		<b>Vehicle serviced</b> - Maintenance inspection completed - Oil and filter changed

12/15/2022

OnStar

**Vehicle equipped with OnStar**

Get 3 free months of premium OnStar with Automatic Crash Response, Roadside Assistance and Remote Door Unlock by pressing the blue OnStar button [Learn more](#)

Have Questions? Please visit our Help Center at [www.carfax.com](http://www.carfax.com).

**Glossary****Accident Indicator**

CARFAX receives information about accidents in all 50 states, the District of Columbia and Canada.

Not every accident is reported to CARFAX. As details about the accident become available, those additional details are added to the CARFAX Vehicle History Report. CARFAX recommends that you have this vehicle inspected by a qualified mechanic.

- According to the National Safety Council, Injury Facts, 2021 edition, 5% of the 276 million registered vehicles in the U.S. were involved in an accident in 2019. Over 77% of these were considered minor or moderate.
- This CARFAX Vehicle History Report is based only on information supplied to CARFAX and available as of 12/15/22 at 5:34:42 PM (CST). Other information about this vehicle, including problems, may not have been reported to CARFAX. Use this report as one important tool, along with a vehicle inspection and test drive, to make a better decision about your next used car.

**Damage Indicator**

Damage can be a result of many different types of events. Examples include contact with objects (other cars, trees, traffic signs, road debris, etc), vandalism, or weather-related events. Not every damage event is reported to CARFAX. As details about the damage event become available, those additional details are added to the CARFAX Vehicle History Report. CARFAX recommends that you have this vehicle inspected by a qualified mechanic.

- This CARFAX Vehicle History Report is based only on information supplied to CARFAX and available as of 12/15/22 at 5:34:42 PM (CST). Other information about this vehicle, including problems, may not have been reported to CARFAX. Use this report as one important tool, along with a vehicle inspection and test drive, to make a better decision about your next used car.

**Damage Severity**

Damage events result in one of the following severity levels:

- Minor: Generally, minor damage is cosmetic (including dents or scratches), may only require reconditioning, and typically does not compromise a vehicle's operation and/or safety.
- Moderate: Moderate damage may affect multiple components of the vehicle and may impair the vehicle's operation and/or safety.
- Severe: Severe damage usually affects multiple components of the vehicle and is likely to compromise the vehicle's operation and/or safety.

CARFAX recommends getting a pre-purchase inspection at a certified collision repair facility.

**First Owner**

When the first owner(s) obtains a title from a Department of Motor Vehicles as proof of ownership.

**New Owner Reported**

When a vehicle is sold to a new owner, the Title must be transferred to the new owner(s) at a Department of Motor Vehicles.

**Ownership History**

CARFAX defines an owner as an individual or business that possesses and uses a vehicle. Not all title transactions represent changes in ownership. To provide estimated number of owners, CARFAX proprietary technology analyzes

all the events in a vehicle history. Estimated ownership is available for vehicles manufactured after 1991 and titled solely in the US including Puerto Rico. Dealers sometimes opt to take ownership of a vehicle and are required to in the following states: Maine, Massachusetts, New Jersey, Ohio, Oklahoma, Pennsylvania and South Dakota. Please consider this as you review a vehicle's estimated ownership history.

#### Title Issued

A state issues a title to provide a vehicle owner with proof of ownership. Each title has a unique number. Each title or registration record on a CARFAX report does not necessarily indicate a change in ownership. In Canada, a registration and bill of sale are used as proof of ownership.

Follow Us:



facebook.com/CARFAX



@CARFAXinc



About CARFAX

CARFAX DEPENDS ON ITS SOURCES FOR THE ACCURACY AND RELIABILITY OF ITS INFORMATION. THEREFORE, NO RESPONSIBILITY IS ASSUMED BY CARFAX OR ITS AGENTS FOR ERRORS OR OMISSIONS IN THIS REPORT. CARFAX FURTHER EXPRESSLY DISCLAIMS ALL WARRANTIES, EXPRESS OR IMPLIED, INCLUDING ANY IMPLIED WARRANTIES OF MERCHANTABILITY OR FITNESS FOR A PARTICULAR PURPOSE.

© 2022 CARFAX, Inc., part of S&P Global. All rights reserved.

12/15/22 5:34:42 PM (CST)



## CARFAX Buyback Guarantee

### CARFAX Buyback Coverage:

12/15/2022 - 12/15/2023

### CARFAX Vehicle Description:

2011 CHEVROLET CORVETTE

#### VIN:

1G1YG3DW2B5106396

#### Body Style:

Convertible

#### Driveline:

Rear wheel drive

#### Engine:

6.2L V8 F OHV 16V

### CARFAX will buy this vehicle back if

you find that any of these severe problems were reported by a Department of Motor Vehicles and were not included in this report.



**Severe Damage:**

Salvage/Junk  
Rebuilt/Reconstructed  
Dismantled  
Fire/Flood/Hail

**Odometer Problems:**

Exceeds Mechanical  
Limits  
Not Actual Mileage

**Lemon history:**

Manufacturer Buyback

**Terms and Conditions Apply**

[View Terms and Conditions for CARFAX Buyback Guarantee coverage](#)

© 2022 CARFAX, Inc., part of S&P Global. All rights reserved.  
12/15/22 5:34:42 PM (CST)