

FIRMAN[®]

OWNER'S MANUAL PORTABLE INVERTER GENERATOR



MODEL NUMBER
W03083

Rev Level:00

IMPORTANT: Read all safety precautions and instructions carefully before operating equipment.



Ensure engine is stopped and level before performing any maintenance or service.

Record product information to reference when ordering parts or obtaining warranty coverage.



**DO NOT RETURN TO
STORE!**



CALL US FIRST!
CUSTOMER HOTLINE
1-844-347-6261

FOR QUESTIONS OR SERVICE
INFORMATION

Serial Number: _____

Purchase Date: _____

P/N:330745452 Rev:00

FCC Statement

1. This device complies with Part 15 of the FCC Rules.

Operation is subject to the following two conditions:

(1) This device may not cause harmful interference.

(2) This device must accept any interference received, including interference that may cause undesired operation.

2. Changes or modifications not expressly approved by the party responsible for compliance could void the user's authority to operate the equipment.

NOTE: This equipment has been tested and found to comply with the limits for a Class B digital device, pursuant to Part 15 of the FCC Rules. These limits are designed to provide reasonable protection against harmful interference in a residential installation.

This equipment generates uses and can radiate radio frequency energy and, if not installed and used in accordance with the instructions, may cause harmful interference to radio communications. However, there is no guarantee that interference will not occur in a particular installation. If this equipment does cause harmful interference to radio or television reception, which can be determined by turning the equipment off and on, the user is encouraged to try to correct the interference by one or more of the following measures:

- Reorient or relocate the receiving antenna.
- Increase the separation between the equipment and receiver.
- Connect the equipment into an outlet on a circuit different from that to which the receiver is connected.

Consult the dealer or an experienced radio/TV technician for help.

Table of Contents

Introduction	1	Maintenance And Storage	23
Safety Precautions	2	Maintenance Schedule	23
Unpacking The Generator	6	Engine Maintenance	24
Parts Included	6	Change Engine Oil	24
Controls and Features	7	Air Filter Maintenance	24
Generator	7	Spark Plug Maintenance	25
Control Panel	8	Inspect Muffler and Spark Arrester	25
Remote Control Programming	9	Generator Maintenance	26
Remote Control Power Consumption	10	Battery Replacement	26
Battery Cable Connection	10	Battery Replacement On Remote	27
Specifications	11	Charging The Generator Battery	27
Add Engine Oil	12	Service and Storage	28
Low Oil Shutdown	12	Trouble Shooting	29
Add Fuel	13	Parts Diagram and Parts List	30
Operation at High Altitude	13	Generator Parts Diagram	30
Grounding	14	Engine Parts Diagram	31
Connecting to a Building's Electrical System	14	Parts List	32
Operation	15	Service Information	34
Generator Location	15	Warranty	34
Surge Protection	15		
Starting the Generator (Recoil Start)	16		
Manual Choke Start	17		
Starting the Generator (Electric Start)	18		
Starting the Generator (Remote Start)	19		
Connecting Electrical Loads	20		
Economy Control Switch	20		
12V DC Outlet (Battery Charger)	21		
Stopping the Engine	21		
Low Oil Shutdown	22		
Do Not Overload Generator	22		
Parallel Operation	22		

INTRODUCTION

Thank you for purchasing a FIRMAN generator.

This manual contains safety information to make you aware of the hazards and risks associated with generator products and how to avoid them. This generator is designed and intended only for supplying electrical power for operating compatible electrical lighting, appliances, tools and motor loads, and is not intended for any other purpose. It is important that you read and understand these instructions thoroughly before attempting to start or operate this equipment.

Save these original instructions for future reference.

This manual covers operation and maintenance of the FIRMAN generators. All information in this publication is based on the latest production information available at the time of approval for printing. The manufacturer reserves the right to change, alter or otherwise improve the generator and this documentation at any time without prior change.

Important Safety Information

The manufacturer cannot possibly anticipate every possible circumstance that might involve a hazard. The warnings in this manual and the tags and decals affixed to the unit are therefore not all-inclusive. If you use a procedure, work method or operating technique that the manufacturer does not specifically recommend you must satisfy yourself that it is safe for you and others. You must also make sure that the procedure work method or operating technique that you choose does not render the generator unsafe.

SAFETY INFORMATION



DANGER

DANGER indicates a potentially hazardous situation which, if not avoided, WILL result in death or serious injury.



WARNING

WARNING indicates a potentially hazardous situation which, if not avoided, could result in death or serious injury.



CAUTION

CAUTION indicates a potentially hazardous situation which, if not avoided, may result in minor or moderate personal injury, or property damage.



Toxic Fumes



Risk of Electric Shock



Fire Hazard



Explosion Hazard



Hot Surface.
Do Not Touch the Surface.



Rotating Parts Entanglement
Hazard





Kickback



Operator's Manual

SAFETY PRECAUTIONS

⚠ DANGER	
Using a generator indoors CAN KILL YOU IN MINUTES . Generator exhaust contains carbon monoxide. This is a poison you cannot see or smell.	
	
NEVER use inside a home or garage, EVEN IF doors and windows are open.	Only use OUTSIDE and far away from windows, doors, and vents.
Avoid other generator hazards. READ MANUAL BEFORE USE.	

⚠ WARNING POISONOUS GAS HAZARD.



Engine exhaust contains carbon monoxide, a poisonous gas that could kill you in minutes. You **CANNOT** smell it, see it, or taste it. Even if you do not smell exhaust fumes, you could still be exposed to carbon monoxide gas.

- Operate this product **ONLY** outside far away from windows, doors and vents to reduce the risk of carbon monoxide gas from accumulating and potentially being drawn towards occupied spaces.
- Install battery-operated carbon monoxide alarms or plug-in carbon monoxide alarms with battery back-up according to the manufacturer's instructions. Smoke alarms cannot detect carbon monoxide gas.
- **DO NOT** run this product inside homes, garages, basements, crawlspaces, sheds, or other partially-enclosed spaces even if using fans or opening doors and windows for ventilation. Carbon monoxide can quickly build up in these spaces and can linger for hours, even after this product has shut off.
- **ALWAYS** place this product downwind and point the engine exhaust away from occupied spaces. If you start to feel sick, dizzy, or weak while using this product, shut it off and get to fresh air **RIGHT AWAY**. See a doctor. You may have carbon monoxide poisoning.

⚠ WARNING

The engine exhaust from this product contains chemicals known to the State of California to cause cancer, birth defects, or other reproductive harm.

⚠ WARNING

Certain components in this product and related accessories contain chemicals known to the State of California to cause cancer, birth defects or other reproductive harm. Wash hands after handling.

- If you start to feel sick, dizzy or weak while using the portable generator, you may have carbon monoxide poisoning. Get out side to fresh air immediately and call 911 for emergency medical attention. Very high levels of CO can rapidly cause victims to lose consciousness before they can rescue themselves. **DO NOT** attempt to shut off the generator before moving to fresh air. Entering an enclosed space where a generator is or has been running may put you at greater risk of CO poisoning.

CORRECT USAGE

Example location to reduce risk of carbon monoxide poisoning

- ONLY use outside and downwind, far away from windows, doors and vents.
- Direct exhaust **AWAY** from occupied spaces.

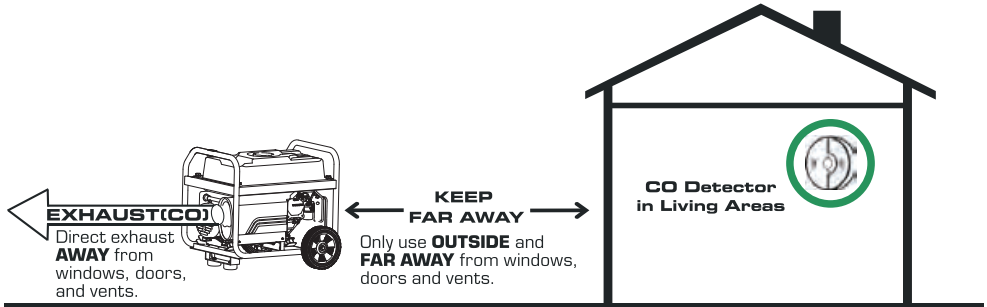

INCORRECT USAGE

Do not operate in any of the following locations:

- Near any door, window or vent
- Garage
- Basement
- Crawl Space
- Living Area
- Attic
- Entry Way
- Porch
- Mudroom

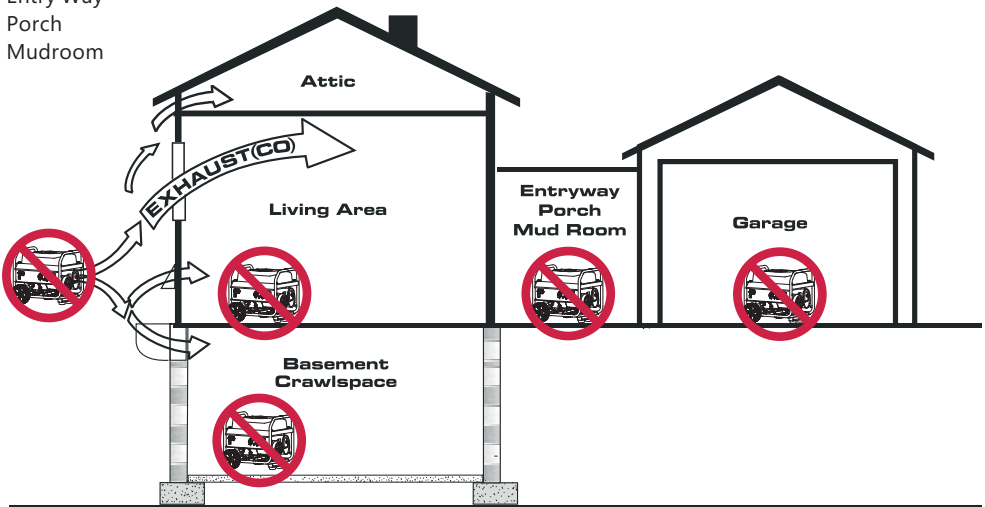

WARNING



Starter cord kickback (rapid retraction) will pull hand and arm toward engine faster than you can let go which could cause broken bones, fractures, bruises, or sprains resulting in serious injury.

- When starting engine, pull cord slowly until resistance is felt and then pull rapidly to avoid kickback.
- **NEVER** start or stop engine with electrical devices plugged in and turned on.

WARNING



Fuel and its vapors are extremely flammable and explosive which could cause burns, fire, or explosion resulting in death or serious injury and/or property damage.

WHEN ADDING OR DRAINING FUEL

- Turn generator engine OFF and let it cool at least 2 minutes before removing fuel cap. Loosen cap slowly to relieve pressure in tank.
- Fill or drain fuel tank outdoors.
- **DO NOT** overfill tank. Allow space for fuel expansion.
- If fuel spills, wait until it evaporates before starting engine.
- Keep fuel away from sparks, open flames, pilot lights, heat, and other ignition sources.
- Check fuel lines, tank, cap, and fittings frequently for cracks or leaks. Replace if necessary.
- **DO NOT** light a cigarette or smoke.

WHEN STARTING EQUIPMENT

- Ensure spark plug, muffler, fuel cap, and air cleaner are in place.
- **DO NOT** crank engine with spark plug removed.

WHEN OPERATING EQUIPMENT

- **DO NOT** operate this product inside any building, carport, porch, mobile equipment, marine applications, or enclosure.
- **DO NOT** tip engine or equipment at angle which causes fuel to spill.
- **DO NOT** stop engine by moving choke control to "Start" position.

WHEN TRANSPORTING, MOVING OR REPAIRING EQUIPMENT

- Transport/move/repair with fuel tank EMPTY or with fuel shutoff valve OFF.
- **DO NOT** tip engine or equipment at angle which causes fuel to spill.
- Disconnect spark plug wire.

WHEN STORING FUEL OR EQUIPMENT WITH FUEL IN TANK

- Store away from furnaces, stoves, water heaters, clothes dryers, or other appliances that have pilot light or other ignition source because they could ignite fuel vapors.

WARNING

- This generator does not meet U. S. Coast Guard Regulation 33CFR-183 and should not be used on marine applications.
- Failure to use the appropriate U. S. Coast Guard approved generator could result in death or serious injury and/or property damage.

WARNING



Generator voltage could cause electrical shock or burn resulting in death or serious injury.

- Use approved transfer equipment, suitable for the intended use, to prevent backfeed by isolating generator from electric utility workers.

- When using generator for backup power, notify utility company.
- Use a ground fault circuit interrupter (GFCI) in any damp or highly conductive area, such as metal decking or steel work.
- **DO NOT** touch bare wires or receptacles.
- **DO NOT** use generator with electrical cords which are worn, frayed, bare or otherwise damaged.
- **DO NOT** operate generator in the rain or wet weather.
- **DO NOT** handle generator or electrical cords while standing in water, while barefoot, or while hands or feet are wet.
- **DO NOT** allow unqualified persons or children to operate or service generator.

WARNING



Exhaust heat/gases could ignite combustibles, structures or damage fuel tank causing a fire, resulting in death or serious injury and/or property damage.

Contact with muffler area could cause burns resulting in serious injury.

- **DO NOT** touch hot parts and **AVOID** hot exhaust gases.
- Allow equipment to cool before touching.
- It is a violation of California Public Resource Code, Section 4442, to use or operate the engine on any forest-covered, brush-covered, or grass-covered land unless the exhaust system is equipped with a spark arrester, as defined in Section 4442, maintained in effective working order. Other states or federal jurisdictions may have similar laws. Contact the original equipment manufacturer, retailer, or dealer to obtain a spark arrester designed for the exhaust system installed on this engine.
- Replacement parts must be the same and installed in the same position as the original parts.

WARNING



Unintentional sparking could cause fire or electric shock resulting in death or serious injury.

WHEN ADJUSTING OR MAKING REPAIRS TO YOUR GENERATOR

- Disconnect the spark plug wire from the spark plug and place the wire where it cannot contact spark plug.

WHEN TESTING FOR ENGINE SPARK

- Use approved spark plug tester.
- **DO NOT** check for spark with spark plug removed.

WARNING



Starter and other rotating parts could entangle hands, hair, clothing, or accessories resulting in serious injury.

- **NEVER** operate generator without protective housing or covers.
- **DO NOT** wear loose clothing, jewelry or anything that could be caught in the starter or other rotating parts.
- Tie up long hair and remove jewelry.

CAUTION

Excessively high operating speeds could result in minor injury. Excessively low operating speeds impose a heavy load.

- **DO NOT** tamper with governor spring, links or other parts to increase engine speed. Generator supplies correct rated frequency and voltage when running at governed speed.
- **DO NOT** modify generator in any way.

NOTE:

Exceeding generators wattage/amperage capacity could damage generator and/or electrical devices connected to it.

- **DO NOT** exceed the generator's wattage amperage capacity.
- Start generator and let engine stabilize before connecting electrical loads.
- Connect electrical loads in OFF position, then turn ON for operation.
- Turn electrical loads OFF and disconnect from generator before stopping generator.

NOTE:

Improper treatment of generator could damage it and shorten its life.

- Use generator only for intended uses.
- If you have questions about intended use, ask dealer or contact local service center.
- Operate generator only on level surfaces.
- DO NOT expose generator to excessive moisture, dust, dirt, or corrosive vapors.
- DO NOT insert any objects through cooling slots.
- If connected devices overheat, turn them off and disconnect them from generator.
- Shut off generator if:
 - Electrical output is lost.
 - Equipment sparks, smokes, or emits flames.
 - Unit vibrates excessively.

WARNING

Medical and Life Support Uses.

- In case of emergency, call 911 immediately.
- NEVER use this product to power life support devices or life support appliances.
- NEVER use this product to power medical devices or medical appliances.
- Inform your electricity provider immediately if you or anyone in your household depends on electrical equipment to live.
- Inform your electrical provider immediately if a loss of power would cause you or anyone in your household to experience a medical emergency.

UNPACKING THE GENERATOR

- Open carton and Remove packaging materials.
- Remove generator, accessories boxes, and literature from carton. If any items are missing or damaged, contact our product service department at 1-844-347-6261.

Parts Included

Your gasoline powered inverter generator ships with the following parts:

1. Engine Oil(Bottle)	1
2. Oil Funnel	1
3. Wrench for Spark Plug	1
4. Screwdriver	1
5. Battery Charge Cable	1
6. Remote	1
7. Manual	1
8. Quick Reference Guide	1
9. Battery Charger(12V DC)	1

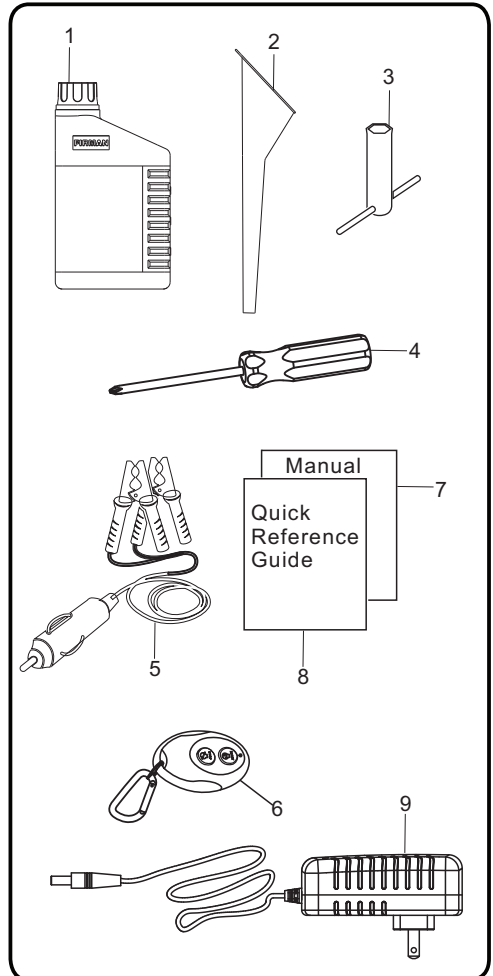

CONTROLS AND FEATURES

Generator

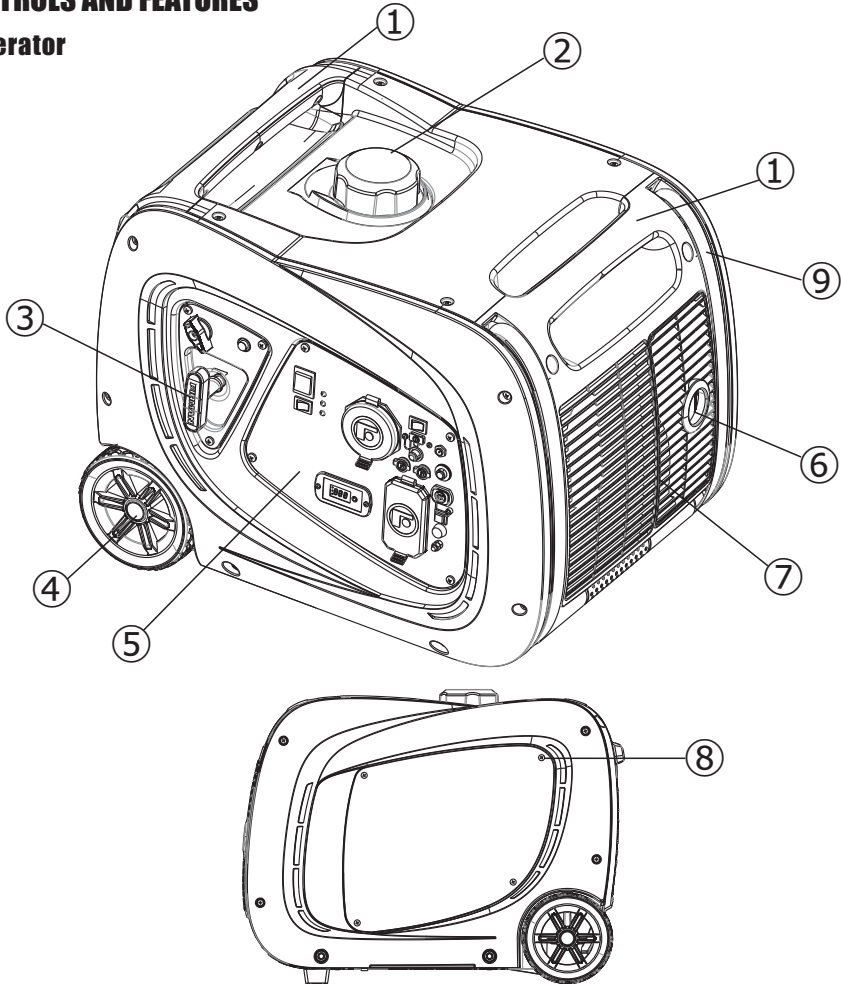

1- Fixed Carrying Handle

2- Fuel Cap

3- Recoil Starter

4- Never Flat Wheel

5- Control Panel

6- Muffler/Spark Arrester

7- Muffler Maintenance Cover

8- Maintenance Cover – Oil filler and air filter access.

9- Folding Handle

*We are always working to improve our products. Therefore, the enclosed product may differ slightly from the image on this page.

Control Panel

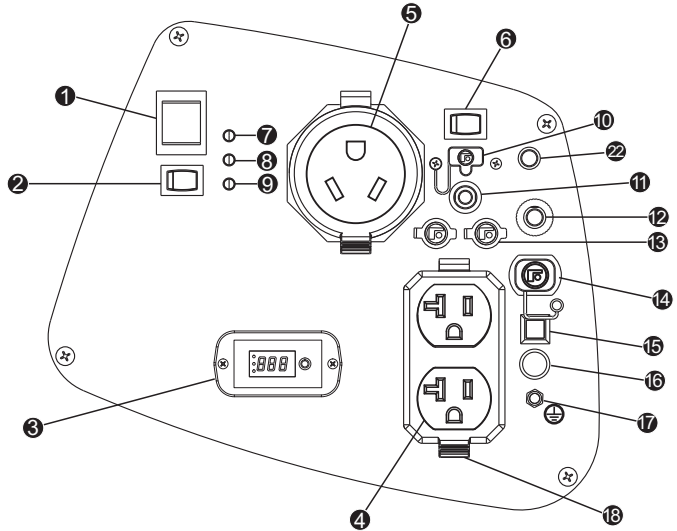
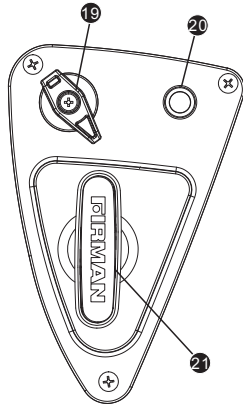

NOTE:

Total power drawn from all receptacles must not exceed the name plate rating.

- 1 Engine Start Switch** – Used to start engine from the starter motor (Electric start model only). To start engine, press and hold the switch in the “**START**”(II) position, the engine will crank and attempt to start. When the engine starts, release the switch to the “**RUN**”(I) position.
- 2 Economy Control Switch**
The Economy Control Switch can be activated in order to minimize fuel consumption and noise while operating the unit during times of reduced electrical output, allowing the engine speed to idle during periods of non-use. The engine speed returns to normal when an electrical load is connected. When the economy switch is off, the engine runs at normal speed continuously.
- 3 3-1 Data-Minder(Multi-Meter)** – Push the SELECT button to show the Voltage, Hertz and running hours.
- 4 120V, 20A Duplex** – (NEMA 5-20R) 20 Amp of current may be drawn from this 120 Volt receptacle.
- 5 120V, 30A RV (NEMA TT-30R)** – Maximum full load 30 Amp current may be drawn from this 120 Volt receptacle.
- 6 Battery Power Restore Switch**- Restore the battery power to the control module. **You must press this switch and hold for 3 seconds before start the generator, including recoil start, electric start and remote start.**
- 7 Output Ready Indicator Light** – Remains “**ON**” during normal operating conditions. Shuts “**OFF**” when generator is overloaded.
The green AC Power Indicator Light comes on when the engine starts and generates power.
- 8 Overload Indicator Light** – This light turns “**ON**” when the generator is overloaded and will cut power to the receptacles.
If the engine overload indicator light comes on, the generator’s wattage / amperage capacity has been exceeded by connected electrical devices or by a power surge. When this occurs, the green AC Power Indicator Light (Item 7) will go off. The engine will continue to run, but the red Engine Overload Indicator Light will stay on and power will no longer be supplied to connected electronic devices.
- 9 Oil Warning Indicator Light** – Check oil level when this light turns “**ON**”. Engine will not run when indicator is lit.
When the oil falls below the minimum level, the oil warning indicator light comes on and the engine stops automatically. The engine will not start until the proper amount of oil is in the crank case.
- 10 DC 5V 2.1A USB Outlet**
- 11 Circuit Breakers** – The receptacles are protected by an AC circuit protector. If the generator is overloaded or an external short circuit occurs, the circuit protector will trip. If this occurs, disconnect all electrical loads and try to determine the cause of the problem before attempting to use the generator again. If overloading causes the circuit protector to trip, reduce the load.
Note: Continuous tripping of the circuit protector may cause damage to generator or equipment. The circuit protector may be reset by pushing the button of the protector.

- ⑫ **DC Circuit Breaker** - The circuit protector may be reset by pushing the button of the protector.
- ⑬ **Parallel Operation Outlets** - These outlets are used for connecting two FIRMAN inverter generators for parallel operation. A FIRMAN parallel kit(optional equipment) is required for parallel operation.
- ⑭ **12V DC outlet** – 8.3 Amp of DC current may be drawn from this receptacle.
Use this outlet to charge 12V automotive type batteries **ONLY**. See 12V DC outlet (Battery Charger) section.
- ⑮ **Remote Start Program Button** - Use this button along with the remote control to program the generator to be started remotely.
- ⑯ **Remote Start Indicator light** - The light will light or flash depending on the status of the remote start system.
- ⑰ **Ground Terminal** – Consult an electrician for local grounding regulations.
- ⑱ **Outlet Cover** - Protect the receptacles from dust and debris.
- ⑲ **Fuel Valve Knob**
- ⑲ **Choke Button**
- ⑲ **Recoil Starter**
- ⑳ **12V DC Battery Charger Port** - Plug the 120 Volt AC charger into this port to charge the generator battery.

Remote Control Programming

Before the generator can be started , an initial start-up procedure must be performed so the generator and the remote control recognize each other.

NOTE:

YOUR REMOTE CONTROL IS ALREADY PROGRAMMED IN FACTORY FOR YOUR CONVENIENCE. AND IT IS READY TO START THE GENERATOR.

If the remote control is replaced then you will need to go through following procedure with new remote control.

1. Flip the engine switch to the "RUN"(I) position.

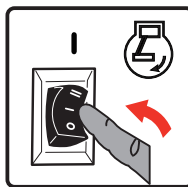

2. Push the battery power restore switch for about 3 seconds and then release.

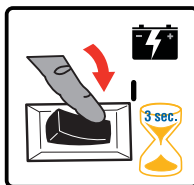

3. Press the program button and hold on, the remote indicator light will light up for about 3 seconds and then be off. After that, release the program button. Erase the remote program successfully.

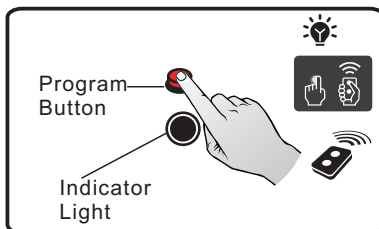

4. Push the program button on the control panel once and the remote indicator light will light up.

5. Push the "START" button on the remote control and hold on. Release the button when the indicator light become off.

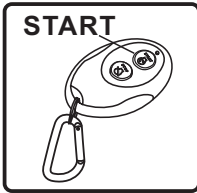

6. The remote control is programmed to generator successfully.

Remote Control Power Consumption

While the Engine Switch is in the "RUN" (I) position and the battery power restore switch has been pressed for about 3 seconds, the remote module is active and waiting for signal. This function requires electrical current which is consuming the battery.

THIS GENERATOR WILL AUTOMATICALLY DISCONNECT THE BATTERY AFTER 12 HOURS TO AVOID BATTERY DRAINAGE, IF THE GENERATOR IS NOT RUNNING AND THE ENGINE SWITCH IS LEFT IN "RUN" (I) POSITION. YOU MUST GO THROUGH STARTING PROCEDURE TO RESUME RUNNING THE UNIT AGAIN.

Battery Cable Connection

Follow below instruction to connect battery to the generator:

1. Unscrew the air cleaner cover by provided screwdriver.
2. Cut wire tie that is binding the black battery cables A and B.

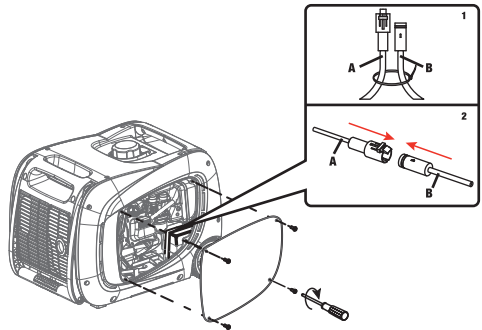

3. Insert the male connector of cable A into female connector of cable B.
4. Reattach the air cleaner cover.

SPECIFICATIONS

Model	W03083
Starting Watts	3300
Running Watts	3000
Rated AC Voltage	120V
Rated Frequency	60Hz
Phase	Single Phase
Voltage regulator	Digital
Power Factor	1
Alternator Type	Magneto Inductor
Engine	FIRMAN
Engine Type	Single Cylinder, 4-Stroke OHV Air Cooled
Displacement	171 cc
Low Oil Shutdown	YES
Ignition System	Breakless Ignition Type, Flywheel Magneto
Starting System	Recoil/Electric Start/Remote Start
Fuel	Unleaded Automotive Gasoline
Capacity Fuel Tank	1.8 Gallon
Lubricating Oil Capacity	20.3 oz(0.6L)
Carburetor Type	Float
Air Cleaner	Polyurethane Type
P.T.O. shaft rotation	Counter Clockwise (Facing P.T.O.)
Oil Type	See "Add Engine Oil" Section
Spark Plug	TORCH F6RTC/NGK BPR6ES/CHAMPION RN9YC

AN IMPORTANT MESSAGE ABOUT TEMPERATURE:

Your Firman Power Equipment product is designed and rated for continuous operation at ambient temperatures up to 40°C (104°F). When your product is needed, your product may be operated at temperatures ranging from -15°C (5°F) to 50°C (122°F) for short periods. If the product is exposed to temperatures outside this range during storage, it should be brought back within this range before operation. In any event, the product must always be operated outdoors, in a well-ventilated area and away from doors, windows and other vents.

- When operated above 77°F(25°C) there may be a decrease in power.
- Maximum wattage and current are subject to and limited by such factors as fuel BTU content ambient temperature, altitude, engine condition and etc. Maximum power decreases about 3.5% for each 1,000 feet above sea level; and will also decrease about 1% for each 10°F(-12.2°C) above 60°F(16°C) ambient temperature.

Add Engine Oil

⚠ CAUTION

DO NOT attempt to crank or start the engine before it has been properly filled with the recommended type and amount of oil. Damage to the generator as a result of failure to follow these instructions will void your warranty.

NOTE:

The recommended oil type is 10W-30 automotive oil. However outdoor temperatures will determine the space proper oil viscosity for the engine. Use the chart to select the best for the outdoor temperature range expected.

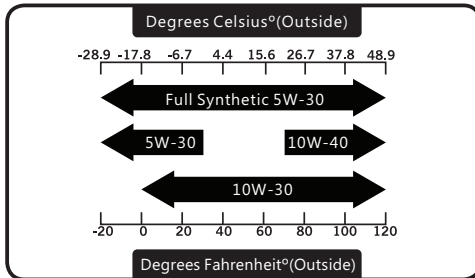

- 1.Place generator on a flat and level surface.
- 2.Looseen the cover screw and remove the maintenance cover.
- 3.Remove oil fill cap/dipstick .
- 4.Using oil funnel, slowly pour contents of provided oil bottle into oil fill opening to the "H" mark on dipstick. Be careful do not overfill. Overfilling with oil could cause the engine to not start or hard starting.

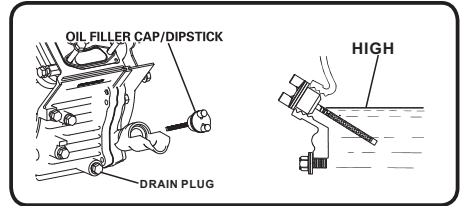
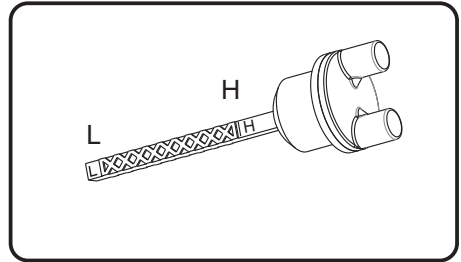
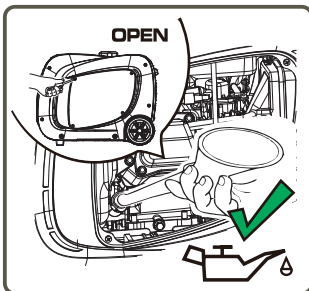

- 5.Replace oil fill cap/dipstick and fully tighten.
- 6.Reinstall maintenance cover and tighten screws.
- 7.Oil Level should be checked prior to each use or at least 8 hours or operation. Keep oil level maintained.

⚠ CAUTION

The engine is equipped with a low oil shut-off and will stop when the oil level in the crankcase falls below the threshold level.

NOTE:

We consider the first 5 hours of run time to be the break-in period for the unit. During the break in period stay at or below 50% of the running watt rating and vary the load occasionally to allow stator windings to heat and cool. Adjusting the load will also cause engine speed to vary and help seat piston rings.

Low oil shutdown

The unit is equipped with a low oil shutdown.If the oil level becomes lower than required,the sensor will activate a warning device or stop the engine.

If generator shuts off and the oil level is within specifications, check to see if generator is sitting at an angle that forces oil to shift. Place on an even surface to correct this. If engine fails to start, the oil level may not be sufficient to deactivate low oil level switch. Make sure the sump is completely full of oil.

Add Fuel

Fuel must meet these requirements:

- Clean, fresh, unleaded gasoline.
- Use regular UNLEADED gasoline with the generator engine with a minimum 87 octane / 87 AKI (91 RON).

For high altitude use, see "Operation at High Altitude".

- Do not use gasoline with more than 10% alcohol such as E85 or ethanol.

NOTE: Avoid generator damage.

Failure to follow Operator's Manual for fuel recommendations voids warranty.

- DO NOT use unapproved gasoline such as E85.
- DO NOT mix oil in gasoline.
- DO NOT modify engine to run on alternate fuels.

WARNING



Fuel and its vapors are extremely flammable and explosive which could cause burns, fire or explosion resulting in death, serious injury and/or property damage.

WHEN ADDING FUEL

- Fill fuel tank outdoors.



DO NOT overfill tank. Allow space for fuel expansion. If the tank is overfilled, fuel can overflow onto a hot engine and cause fire or explosion. Wipe up any spilled fuel immediately.

- If fuel spills, wait until it evaporates before starting engine.
- Keep fuel away from sparks, open flames, pilot lights, heat, and other ignition sources.
- Check fuel lines, tank, cap and fittings frequently for cracks or leaks. Replace if necessary.



DO NOT light a cigarette or smoke when filling the fuel tank.

1. Clean area around fuel fill cap, remove cap.
2. Slowly add unleaded fuel to fuel tank. Be careful not to fill above the red fuel level indicator. This allows adequate space for fuel expansion.
3. Install fuel cap and let any spilled fuel evaporate before starting engine or wipe up any spilled gasoline.

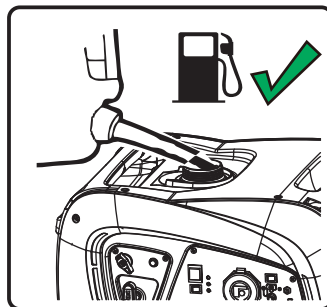

CAUTION

- Slowly add unleaded gasoline to fuel tank.
- Do not overfill tank.
- Do not fill above the red fuel level indicator. This will allow expansion in hot weather and prevent overflow.

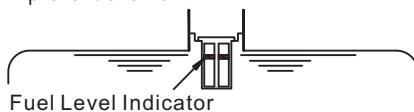

IMPORTANT: It is important to prevent gum deposits from forming in fuel system parts such as the carburetor, fuel hose or tank during storage. Alcohol-blended fuels (called gasohol, ethanol or methanol) can attract moisture, which leads to separation and formation of acids during storage. Acidic gas can damage the fuel system of an engine while in storage. To avoid engine problems, the fuel system should be emptied before storage of 30 days or longer. See the " Long Term Storage" section. Never use engine or carburetor cleaner products in the fuel tank as permanent damage may occur.

Operation at High Altitude

At altitudes over 5,000 feet (1524 meters), a minimum 85 octane / 85 AKI (89 RON) gasoline is acceptable.

The density of air at high altitude is lower than at sea level. Engine power is reduced as the air mass and air-fuel ratio decrease. Engine power and generator output will be reduced approximately 3.5% for every 1000 feet of elevation above sea level. This is a natural trend and cannot be changed by

adjusting the engine. At high altitudes increased exhaust emissions can also result due to the increased enrichment of the air fuel ratio. Other high altitude issues can include hard starting, increased fuel consumption and spark plug fouling. To alleviate high altitude issues other than the natural power loss, **FIRMAN** can provide a high altitude carburetor main jet. The alternative main jet and installation instructions can be obtained by contacting Customer Support. Installation instructions are also available in the Technical Bulletin area of the FIRMAN internet site.

The part number and recommended minimum altitude for the application of the high altitude carburetor main jet is listed in the table below.

	171cc	Altitude
Altitude main jet 1	330717002	3000-6000Feet
Altitude main jet 2	330717003	6000-8000Feet

WARNING

Operation using the alternative main jet at elevations lower than the recommended minimum altitude can damage the engine. For operation at lower elevations, the standard main jet must be used. Operating the engine with the wrong engine configuration at a given altitude may increase its emissions and decrease fuel efficiency and performance.

Grounding

The National Electric Code requires your generator must be properly connected to an appropriate ground to help prevent electric shock.

WARNING



Failure to properly ground the generator can result in electric shock.

A ground terminal connected to the frame of the generator has been provided on the control panel. For remote grounding, connect a length of heavy gauge (12 AWG minimum) copper wire between the generator ground terminal and a copper rod driven into the

ground. We strongly recommend that you consult with a qualified electrician to ensure compliance with local electrical codes.

THERE IS A PERMANENT CONDUCTOR BETWEEN THE GENERATOR (STATOR WINDING) AND THE FRAME.

Connecting to a Building's Electrical System

Connections for standby power to a building's electrical system must be made by a qualified electrician. The connection must isolate the generator power from utility power or other alternative power sources and must comply with all applicable laws and electrical codes.

WARNING



Generator voltage could cause electrical shock or burn resulting in death or serious injury.

- Use approved transfer equipment to prevent backfeed by isolating generator from electric utility workers.
- When using generator for backup power, notify utility company.
- Use a ground fault circuit interrupter (GFCI) in any damp or highly conductive area, such as metal decking or steel work.
- DO NOT touch bare wires or receptacles.
- DO NOT use generator with electrical cords which are worn, frayed, bare or otherwise damaged.
- DO NOT operate generator in the rain or wet weather.
- DO NOT handle generator or electrical cords while standing in water, while barefoot, or while hands or feet are wet.
- DO NOT allow unqualified persons or children to operate or service generator.

OPERATION

Generator Location

WARNING

Make sure you review each warning in order to prevent fire hazard.

- Keep area clear of inflammables or other hazardous materials.
- Select a site that is dry, well ventilated and protected from the weather.
- Keep exhaust pipe clear of foreign objects.
- Keep generator away from open flame.
- Keep generator on a stable and level surface.

CAUTION

Tilting can cause fuel spillage.



- Do not block generator air vents with paper or other material.

DANGER

Using a generator indoors **CAN KILL YOU IN MINUTES.**

Generator exhaust contains carbon monoxide. This is a poison you cannot see or smell.



NEVER use inside a home or garage, **EVEN IF** doors and windows are open.



Only use **OUTSIDE** and far away from windows, doors, and vents.

Avoid other generator hazards.
READ MANUAL BEFORE USE.

WARNING

POISONOUS GAS HAZARD.



Engine exhaust contains carbon monoxide, a poisonous gas that could kill you in minutes. You **CANNOT** smell it, see it, or taste it. Even if you do not smell exhaust fumes, you could still be exposed to carbon monoxide gas.

- Operate this product **ONLY** outside far away from windows, doors and vents to reduce the risk of carbon monoxide gas from accumulating and potentially being drawn towards occupied spaces.
- Install battery-operated carbon monoxide alarms or plug-in carbon monoxide alarms with battery back-up according to the manufacturer's instructions. Smoke alarms cannot detect carbon monoxide gas.
- **DO NOT** run this product inside homes, garages, basements, crawlspaces, sheds, or other partially-enclosed spaces even if using fans or opening doors and windows for ventilation. Carbon monoxide can quickly build up in these spaces and can linger for hours, even after this product has shut off.
- **ALWAYS** place this product downwind and point the engine exhaust away from occupied spaces. If you start to feel sick, dizzy, or weak while using this product, shut it off and get to fresh air **RIGHT AWAY**. See a doctor. You may have carbon monoxide poisoning.

Surge Protection

CAUTION

Voltage fluctuation may impair the proper functioning of sensitive electronic equipment.

Electronic devices, including computers and many programmable appliances use components that are designed to operate within a narrow voltage range and may be affected by momentary voltage fluctuations. While there is no way to prevent voltage fluctuations, you can take steps to protect sensitive electronic equipment.

Install UL1449, CSA-listed, plug-in surge suppressors on the outlets feeding your sensitive equipment. Surge suppressors come in single- or multi-outlet styles. They're designed to protect against virtually all short-duration voltage fluctuations.

Starting the Generator (Recoil Start)

1. Before starting the generator, check for loose or missing parts and for any damage which may have occurred during shipment.
2. Check oil level and fuel.

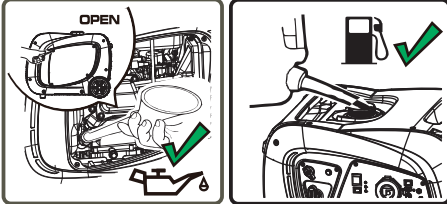

3. Disconnect all electrical loads from the generator. Never start or stop the generator with electrical devices plugged in or turned on.

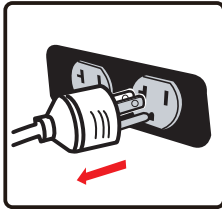

4. Turn the fuel valve to the "ON" (I) position.

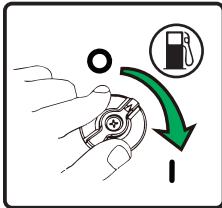

5. Flip the engine switch to the "RUN" (I) position.

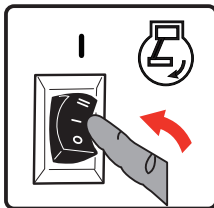

6. Push the battery power restore switch for about 3 seconds and then release.

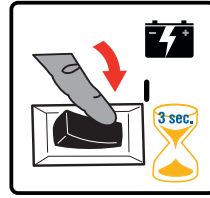

7. Push the choke button to the "CHOKE" position.

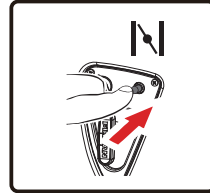

8. Pull the starter cord slowly until resistance is felt and then pull rapidly.

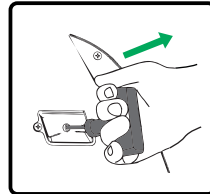

9. Push the choke button to the "RUN" position.



10. Allow generator to run at no load for few minutes upon each initial start-up to permit engine and generator to stabilize.

WARNING



Starter cord kickback (rapid retraction) will pull hand and arm toward engine faster than you can let go which could cause broken

bones, fractures, bruises, or sprains resulting in serious injury.

When starting engine, pull cord slowly until resistance is felt and then pull rapidly to avoid kickback.

NOTE:

Keep choke lever in "CHOKE" position for only 1 pull of the recoil starter. After first pull, move choke lever to the "RUN" position for up to the next 3 pulls of the recoil starter. Too much choke leads to sparkplug fouling/engine flooding due to the lack of incoming air. This will cause the engine not to start.

NOTE:

If engine starts after 3 pulls but fails to run, or if unit shuts down during operation, make sure unit is on a level surface and check for proper oil level in crankcase. This unit may be equipped with a low oil protection device. If so, oil must be at proper level for engine to start.

Manual Choke Start (When the battery is dead)

If the battery is dead or not able to produce enough current to power the push button choke, the choke itself can be operated manually to help start the engine. To manually choke and start the inverter, follow these steps:

1. Loosen the screws and remove the maintenance cover.

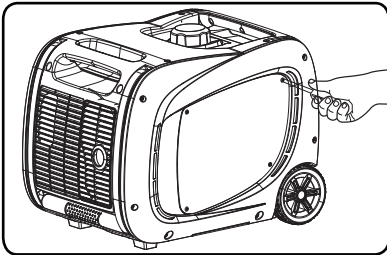

2. Locate the yellow manual choke lever.

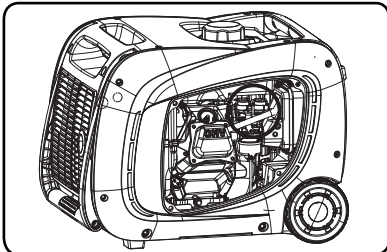

3. Turn the choke lever to the "CHOKE" (right) position.

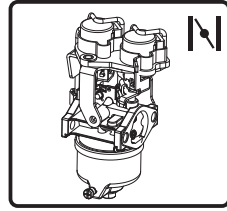

4. Turn the fuel valve to the "ON" (I) position.

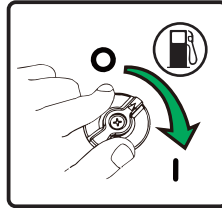

5. Flip the engine switch to the "RUN" (I) position.

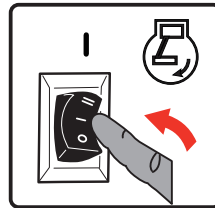

6. Pull the starter cord slowly until resistance is felt and then pull rapidly.

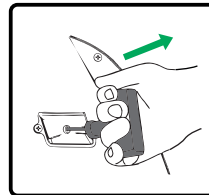

8. As the engine starts to roll over, move the choke lever to the "RUN" (left) position.

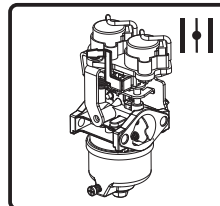

9. Allow generator to run at no load for few minutes upon each initial start-up to permit engine and generator to stabilize.

Starting the Generator (Electric Start)

Electric Start and Remote Start Operations

This model is provided with recoil start, electric start and remote start capabilities. The charger is a low amperage maintenance type charger. It will charge your battery as your generator runs. Avoid prolonged cranking, as it can damage the engine.

⚠ WARNING

Storage batteries give off **EXPLOSIVE** hydrogen gas while charging. Do not allow smoking, open flames, sparks, or spark producing equipment in the area while charging.

⚠ WARNING

Battery electrolyte fluid is comprised of sulfuric acid that can be very dangerous and cause severe burns. Do not allow this fluid to contact eyes, skin, clothing, etc. If contact or spillage does occur, flush the area with water immediately.

1. Before starting the generator, check for loose or missing parts and for any damage which may have occurred during shipment.
2. Check oil level and fuel.

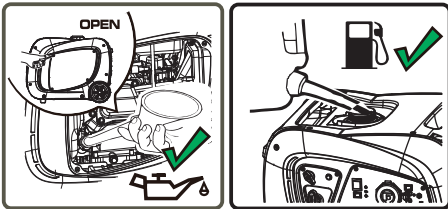

3. Disconnect all electrical loads from the generator. Never start or stop the generator with electrical devices plugged in or turned on.

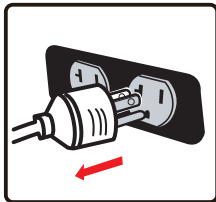

4. Turn the fuel valve to the "ON" (I) position.

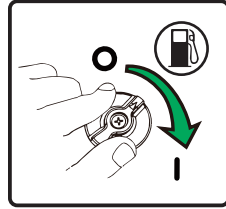

5. Flip the engine switch to the "RUN" (I) position.

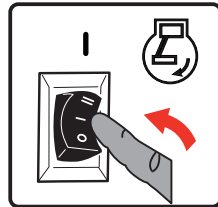

6. Push the battery power restore switch for about 3 seconds and then release.

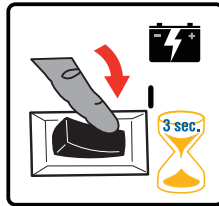

7. Push the choke button to the "CHOKE" position.

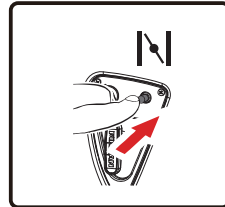

8. Press and hold the engine switch in the "START" (II) position for few seconds and release the switch to the "RUN" (I) position.

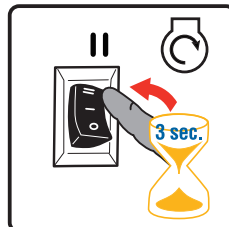

9. Push the choke button to the "RUN" position.

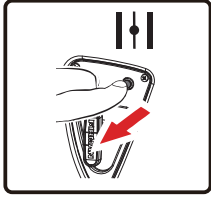

10. Allow generator to run at no load for few minutes upon each initial start-up to permit engine and generator to stabilize.

Starting the Generator (Remote Start)

The generator can be started remotely from up to a maximum of 164 feet away using the remote control with new fully charged batteries in the remote control. As the batteries state of charge in the remote control reduces, the distance to start the generator will also reduce. (Wireless signal may not pass through some solid objects.)

NOTE:

YOUR REMOTE CONTROL IS ALREADY PROGRAMMED IN FACTORY FOR YOUR CONVENIENCE. AND IT IS READY TO START THE GENERATOR.

If the remote control is replaced, then you will need to go through programming procedure in "Remote Control Programming" section.

1. Before starting the generator, check for loose or missing parts and for any damage which may have occurred during shipment.
2. Check oil level and fuel.

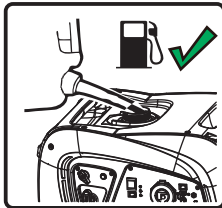
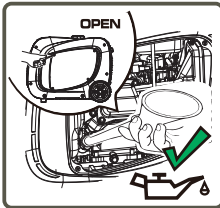

3. Disconnect all electrical loads from the generator. Never start or stop the generator with electrical devices plugged in or turned on.

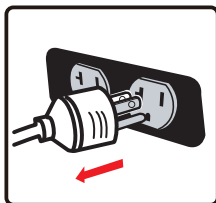

4. Turn the fuel valve to the "ON" (I) position.

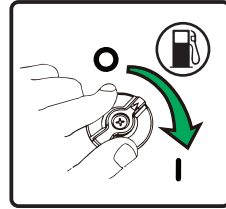

5. Flip the engine switch to the "RUN" (I) position.

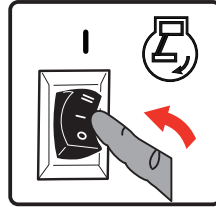

6. Push the battery power restore switch for about 3 seconds and then release.

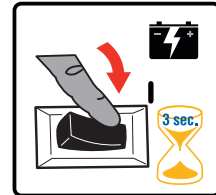

7. Push and release the "START" button on the remote control. The generator will turn over for 3 to 5 seconds and start.

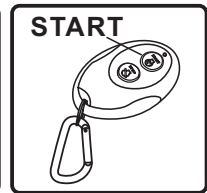
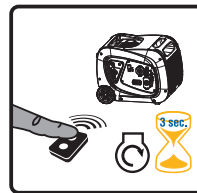

An engine warmup delay is programmed into the remote start cycle. After the generator is running, there will be a delay of electrical output for 15 seconds.

If the engine fails to start within 3 to 5 seconds, the engine will attempt to start five additional times. If the generator failed to start, the remote start indicator light will flash.

If the generator fails to start after a total of six attempts, the start button on the remote control must be pushed again to begin another cycle of six start attempts.

8. Allow generator to run at no load for few minutes upon each initial start-up to permit engine and generator to stabilize.

Remote Control Power Consumption

While the Engine Switch is in the "RUN" (I) position and the battery power restore switch has been pressed for about 3 seconds, the remote module is active and waiting for signal. This function requires electrical current which is consuming the battery.

THIS GENERATOR WILL AUTOMATICALLY DISCONNECT THE BATTERY AFTER 12 HOURS TO AVOID BATTERY DRAINAGE, IF THE GENERATOR IS NOT RUNNING AND THE ENGINE SWITCH IS LEFT IN "RUN" (I) POSITION. YOU MUST GO THROUGH STARTING PROCEDURE TO RESUME RUNNING THE UNIT AGAIN.

Connecting Electrical Loads

This unit has been pretested and adjusted to handle its full capacity. Before starting the generator, disconnect all load. Apply load only after generator is running. Voltage is regulated via the engine speed adjusted at the factory for correct output. Readjusting will void warranty.

CAUTION

When applying a load, do not exceed the maximum wattage rating of the generator when using one or more receptacles. Also, do not exceed the amperage rating of any one receptacle.

Do not apply heavy electrical load during break-in period (the first five hours of operations).

1. Let engine stabilize and warm up for a few minutes after starting.
2. Ensure circuit breaker on control panel is in on position.
3. Plug in and turn on the desired 120 Volt AC, single phase, 60Hz electrical loads. It is better to attach the item with largest load first.

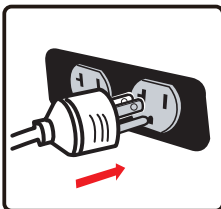

NOTE:

Connecting a generator to your electric utility company's power lines or to another power source may be against the law. In addition this action, if done incorrectly, could damage your generator and appliances and could cause serious injury or even death to you or a utility worker who may be working on nearby power lines. If you plan to run a portable electric generator during an outage, please notify your electric utility company immediately and remember to plug your appliances directly into the generator. Do not plug the generator into any electric outlet in your home. Doing so could create a connection to the utility company power lines. You are responsible for ensuring that your generator's electricity does not feed back into the electric utility power lines. If the generator will be connected to a building electrical system, consult your local utility company or a qualified electrician. Connections must isolate generator power from utility power and must comply with all applicable laws and codes.

Economy Control Switch

The Economy Control switch can be activated in order to minimize fuel consumption and noise while operating the unit during times of reduced electrical output, allowing the engine speed to idle during periods of non-use. The engine speed returns to normal when an electrical load is connected. When the economy switch is off, the engine runs at normal speed continuously.

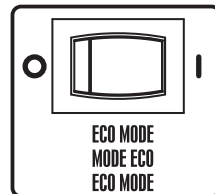

WARNING

For periods of high electrical load or momentary fluctuations, the Economy Control Switch should be turned OFF.

12V DC Outlet (Battery Charger)

The 12V DC outlet is ONLY to be used with the supplied 12V battery charging cable. The DC output is unregulated and will damage other 12V DC products.

The amount of current flowing will depend on the charging voltage and battery's state of charge. As the battery becomes more fully charged, the output current to the battery decreases and nearly becomes constant. Taper chargers are intended to be used with the provision that they will be disconnected from the battery after a maximum time on charge. Normally a period of 30 to 120 minutes is sufficient to recharge a weak battery. The charge level of the battery should be checked periodically.

⚠ CAUTION

- For use with 12V direct current outlet, always keep the ECO mode deactivated (OFF Position).
 - You can use the 12V direct current outlet and the 230V current at the same time, but keep the ECO mode deactivated (OFF Position) at all times.
- Do not start the vehicle while the battery charging Cable is connected and the generator is running. It will not give the battery a boost of power. The Vehicle or the generator may be damaged. Charge only vented wet lead acid batteries. Other types of batteries may burst, causing personal injury or damage.

⚠ WARNING

Storage batteries give off EXPLOSIVE hydrogen gas while charging. Do not allow smoking, open flames, sparks, or spark producing equipment in the area while charging.

⚠ WARNING

Battery electrolyte fluid is comprised of sulfuric acid that can be very dangerous and cause severe burns. Do not allow this fluid to contact eyes, skin, clothing, etc. If contact or spillage does occur, flush the area with water immediately. Do not continue to charge a battery that becomes hot or is fully charged.

1. Before connecting the battery charging cable to a battery that is installed in a vehicle, disconnect the vehicle battery ground cable from the negative (-) battery terminal.
2. Plug the battery charging cable into the DC receptacle of the generator.

3. Connect the red (+) battery charger lead to the red (+) battery terminal.
4. Connect the black (-) battery charger lead to the black (-) battery terminal.
5. Start the generator.

NOTE:

When the battery circuit is in use the AC capacity is reduced by 100 watts. Make sure the combined load is within the rated limits.

⚠ WARNING

Do not continue to charge a battery that becomes hot or is fully charged.

DC CIRCUIT PROTECTOR

A DC circuit protector has been provided to protect the circuit from overloads. If an overload occurs, the circuit protector will trip. The circuit protector may be reset by pushing the button of the protector.

Charging a large capacity battery or a totally discharged battery may cause the DC breaker to turn off. In these cases, a separate battery charger unit connected to an AC power source is recommended instead of the DC receptacle on the generator.

Stopping the Engine

1. Turn off and remove entire electrical loads. Never start or stop the generator with electrical devices plugged in or turned on.

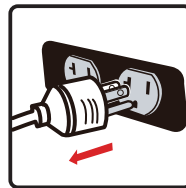

Let the generator run at no-load for two minutes to stabilize internal temperatures of the engine and generator.

2. Remote Start Operation

Push and release the "STOP" button on the remote control. The generator will be shut down.

Note: Skip this step and go to step 3, if you are not using Remote Start to shutdown the engine.

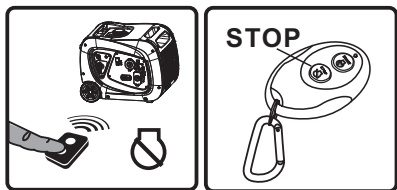

3. Electric Start and Recoil Start Operations

Flip the engine switch to "OFF" (O) position.

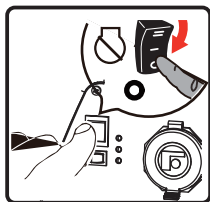

4. Turn the fuel valve to the "OFF" (O) position.



If a cover is used, do not install until unit has cooled.

NOTE:

If the engine will not be used for a period of two weeks or longer, please see the Storage section for proper engine and fuel storage.

Low Oil Shutdown

If the engine oil drops below a preset level, an oil switch will stop the engine. Check oil level with dipstick.

If oil level is between the **LOW** and **HIGH** mark on dipstick:

1. DO NOT try to restart the engine.
2. Contact an Authorized FIRMEN Service Dealer.
3. DO NOT operate engine until oil level is corrected.

If oil level is below the **LOW** mark on dipstick:

1. Add oil to bring level to **HIGH** mark.
2. Restart engine and if the engine stops again a low oil condition may still exist. DO NOT try to restart the engine.
3. Contact an Authorized FIRMEN Service Dealer.
4. DO NOT operate engine until oil level is corrected.

Do Not Overload Generator

Overloading a generator in excess of its rated wattage capacity can result in damage to the generator and to connected electrical devices.

To prolong the life of your generator and attached devices, follow these steps to add electrical load:

1. Start the generator with no electrical load attached.
2. Allow the engine to run for several minutes to stabilize.
3. Plug in and turn on the first item. It is best to attach the item with the largest load first.
4. Allow the engine to stabilize.
5. Plug in and turn on the next item.
6. Allow the engine to stabilize.
7. Repeat steps 5-6 for each additional item.

Overload Operation

The overload indicator light will turn on and cut power to the receptacles after 30 seconds when the load exceeds 3080W (approximately).

The overload indicator light will turn on and cut power to the receptacles after 2 seconds when the load exceeds 3150W (approximately).

How to Correct

1. Disconnect any electronic devices, and then stop the engine.
2. Reduce the total wattage of connected electronic devices until it is within the generator's rated output.
3. Inspect the Air Inlet and Control Panel for any blockage. Remove blockage if found.
4. Restart Engine.

Parallel Operation

Any two FIRMEN inverter generator with parallel port including two FIRMEN inverter model W03083 can be paralleled to increase the total available electrical power to 5500 Watts. A FIRMEN Parallel kit (not included) is required for parallel operation. For Kit availability, call customer Service at 1-844-347-6261 or visit: www.firmengenerators.com.

CAUTION:

DO NOT disconnect parallel cables while generator is running.

MAINTENANCE AND STORAGE

MAINTENANCE SCHEDULE

ITEM	NOTES	Daily(Before operation)	Initial 25 hours	Every 50 hours	Every 100 hours (or annual)
Spark Plug	Check condition. Adjust gap and clean. Replace if necessary.				✓
Engine Oil	Check oil level.	✓			
	Replace.		✓		✓
Air Filter	Clean, replace if necessary.			✓	
Fuel Filter	Clean fuel filter and fuel tank strainer. Replace if necessary.				✓
Fuel Line	Check fuel hose for cracks or other damage. Replace if necessary.	✓			
Exhaust System	Check for leakage. Retighten or replace gasket if necessary.	✓			
	Check spark arrester screen. Clean/Replace if necessary.				✓
Carburetor	Check choke operation.	✓			
Starting System	Check recoil starter operation.	✓			
Fittings/ Fasteners	Check. Replace if necessary.				✓

General Recommendations

Regular maintenance will improve the performance and extend the life of the generator. See any authorized dealer for service.

The generator's warranty does not cover items that have been subjected to operator abuse or negligence. To receive full value from the warranty, the operator must maintain the generator as instructed in this manual.

Some adjustments will need to be made periodically to properly maintain your generator.

All service and adjustments should be made at least once each season. Follow the requirements in the Maintenance Schedule chart above.

Notice Once a year you should clean or replace the spark plug and replace the air filter. New spark plugs and clean air filter assure proper fuel-air mixture and help your engine run better and last longer.

ENGINE MAINTENANCE

To prevent accidental starting, remove and ground spark plug wire before performing any service.

Change Engine Oil

Change engine oil every 100 hours.
(for a new engine, change oil after 25 hours.)

If you are using your generator under extremely dirty or dusty conditions, or in extremely hot weather, change the oil more often.

CAUTION

Avoid prolonged or repeated skin contact with used motor oil.

- Used motor oil has been shown to cause skin cancer in certain laboratory animals.
 - Thoroughly wash exposed areas with soap and water.
- (a) Loosen the cover screws and remove the maintenance cover.



- (b) Pop up the rubber plug from below yellow draining bolt.

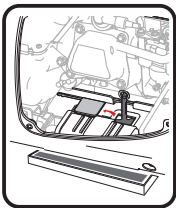

- (c) Remove yellow drain bolt.
(d) Tilt the generator on its side and allow the oil to drain completely.
(e) Replace yellow drain bolt.
(f) Fill the engine with oil until it reaches the **HIGH** (H) level on the oil filler cap. **DO NOT OVERFILL.**

- Use fresh and high quality lubricating oil to the specified quantity.
If contaminated or deteriorated oil is used or the quantity of the engine oil is not sufficient, the engine damage will result and its life will be greatly shortened.

Air Filter Maintenance

Maintaining an air filter in proper condition is very important. Dirt induced through improperly installed, improperly serviced, or inadequate elements damages and wears out engines. Always keep the element clean.

- (a) Remove the air cleaner cover and locate the air filter plastic cover.

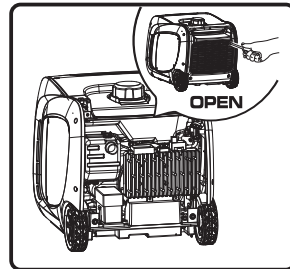

- (b) Remove the foam element.

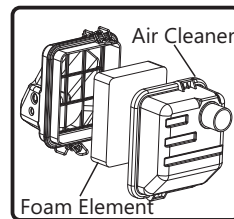

- (c) After wetting the element by clean engine oil squeeze it tight by hand.

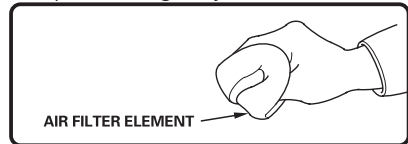

- (d) Put the element in the case and install it securely.
(e) Reattach the air filter cover.
(f) Reinstall the air cleaner cover and tighten the cover screw securely.

Spark Plug Maintenance

Changing the spark plug will help your engine to start easier and run better.

(a) Remove the maintenance cover.

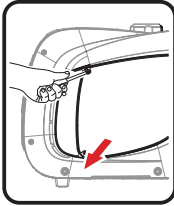

(b) Remove the spark plug cable from the spark plug.

(c) Remove spark plug using provided wrench.

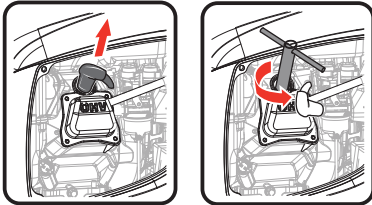

(d) Inspect spark plug for damage and clean with a wire brush before reinstalling

(e) Adjust the electrode gap to 0.7 to 0.8 mm (0.028" to 0.031").

(f) Seat spark plug in position and thread by hand to prevent cross threading.

(g) Tighten plug with provided wrench and put the cap back on spark plug.

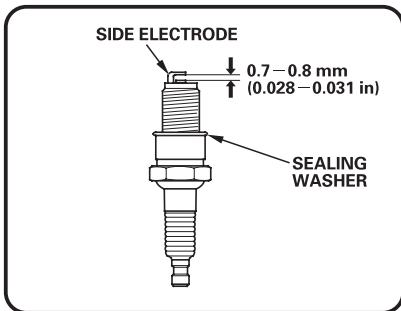

SPARK PLUG: TORCH F6RTC
NGK BPR6ES
CHAMPION RN9YC

Inspect Muffler and Spark Arrester

Inspect the muffler for cracks, corrosion, or other damage. Remove the spark arrester, if equipped, and inspect for damage or carbon blockage. If replacement parts are required, make sure to use only original equipment replacement parts.

⚠ WARNING



Exhaust heat/gases could ignite combustibles, structures or damage fuel tank causing a fire, resulting in death or serious injury and/or property. Contact with muffler area could cause burns resulting in serious injury.

- **DO NOT** touch hot parts and **AVOID** hot exhaust gases.
- Allow equipment to cool before touching.
- Keep at least 5 feet (1.5 m) of clearance on all sides of generator including overhead.
- Replacement parts must be the same and installed in the same position as the original parts.

Clean or replace spark arrester as follows:

Depending on the type fuel used, the type and amount of lubricant used, and/or your operating conditions, the exhaust part and muffler may become blocked with carbon deposits. If you notice power loss, you may need to remove these deposits to restore performance.

1. Allow the engine to cool completely before servicing the spark arrester.
2. Loosen the spark arrester clamp, remove the spark arrester cover, and with a thin blade screwdriver remove the spark arrester.

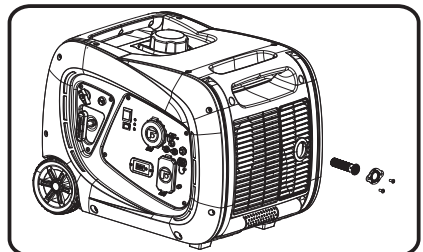

- Carefully remove the carbon deposits from the spark arrester screen with a wire brush.

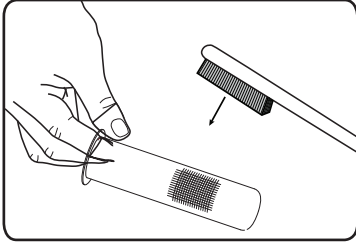

- Replace the spark arrester if it is damaged.
- Position the spark arrester in the muffler and attach spark arrester cover with the screws.

⚠ CAUTION

Failure to clean the spark arrester will result in degraded engine performance.

GENERATOR MAINTENANCE

Make certain that the generator is kept clean and stored properly. Only operate the unit on a flat, level surface in a clean, dry operating environment. **DO NOT** expose the unit to extreme conditions, excessive dust, dirt, moisture or corrosive vapours.

⚠ CAUTION

DO NOT use a garden hose to clean the generator. Water can enter the generator through the cooling slots and damage the generator windings.

Use a damp cloth to clean exterior surfaces of the generator.

Use a soft bristle brush to remove dirt and oil. Use an air compressor (25 PSI) to clear dirt and debris from the generator.

Inspect all air vents and cooling slots to ensure that they are clean and unobstructed.

Battery Replacement

- Unscrew the air cleaner cover by provided screwdriver.

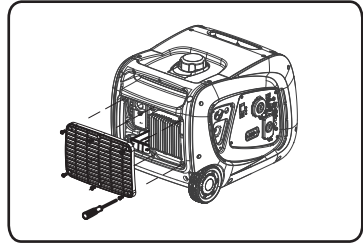

- Release the battery retaining rubber belt.
- Remove the protective cover (rubber sheath) from battery.
- Disconnect the black(-) cable from black(-) terminal on the battery.
- Disconnect the red(+) cable from red(+) terminal on the battery.

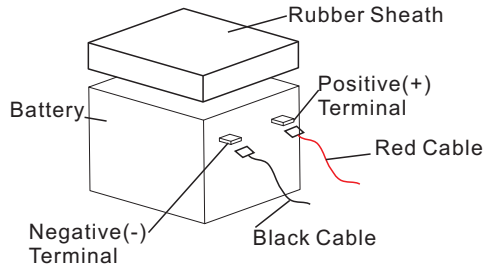

- Pull out the battery and replace with new battery: 12V sealed lead acid 5.5AH LXWXH:90X70X100mm(3.54X2.76X3.84in)
- Connect the red(+) battery cable to the positive terminal of battery first and then connect the black(-) battery cable to the negative terminal of battery.
- Reattach the air cleaner cover.

⚠ WARNING



To avoid electric shock:

ALWAYS connect the positive (+) battery cable (red boot) first when connecting battery cables.

ALWAYS disconnect the negative (-) battery cable (black boot) first when disconnecting battery cables.

NEVER connect the negative (-) battery cable (black boot) to the positive (+) post on the battery.

NEVER connect the positive (+) battery cable (red boot) to the negative (-) post on the battery.

NEVER touch both battery posts simultaneously.

NEVER place a metal tool across both battery posts.

ALWAYS use insulated or nonconducting tools when installing the battery.

Battery Replacement On Remote

1. Loosening and remove cover screws.
2. Remove the cover.

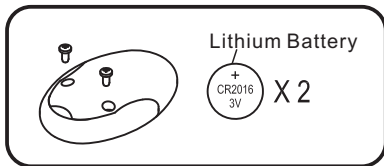

3. Remove the depleted batteries and insert two new CR2016 lithium batteries with the "+" terminal facing up.
4. Close the remote cover and tight the screws.

Charging The Generator Battery

WARNING

Storage batteries give off EXPLOSIVE hydrogen gas while charging. Do not allow smoking, open flames, sparks, or spark producing equipment in the area while charging.

WARNING

Battery electrolyte fluid is comprised of sulfuric acid that can be very dangerous and cause severe burns. Do not allow this fluid to contact eyes, skin, clothing, etc. If contact or spillage does occur, flush the area with water immediately.

To ensure the battery remains charged, the supplied battery charger should be plugged into the generator. Plug the cord from the charger into the charging port on the generator control panel. Plug the charger into a 120 volt AC wall outlet.

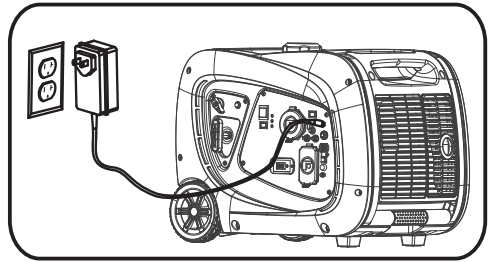

There is a light on the charger. This light will remain red until the battery get charged and then it will be changed to green. The charger won't charge the battery or will stop charging when the light is green to prevent any damage to battery and generator.

Unplug battery charger from wall outlet and generator control panel when generator is going to be used.

SERVICE AND STORAGE

Infrequent Service

If the unit is used infrequently, difficult starting may result. To eliminate hard starting, follow these instructions:

1. Run the generator at least 30 minutes every month.
2. Run the generator, then close the fuel shut-off valve and allow the unit to run until the engine stops.
3. Move the engine switch to the "OFF" position.

Long Term Storage

It is important to prevent gum deposits from forming in essential fuel system parts such as the carburetor, fuel hoses or tank during storage. Also, experience indicates that alcohol-blended fuels (called gasohol, ethanol or methanol) can attract moisture, which leads to separation and formation of acids during storage. Acidic gas can damage the fuel system of an engine while in storage.

When the generator set is not being operated, or is being stored more than one month, follow these instructions to avoid engine problems:

- 1-**ADD** a properly formulated commercially **FUEL STABILIZER** to the tank if it is not already added.
- 2-Operate the engine for 5-10 minutes to circulate treated fuel into fuel lines and carburetor before shutdown.
- 3- After engine cools down, remove all gasoline from the fuel tank. Use a commercially available, non-conductive vacuum siphon.

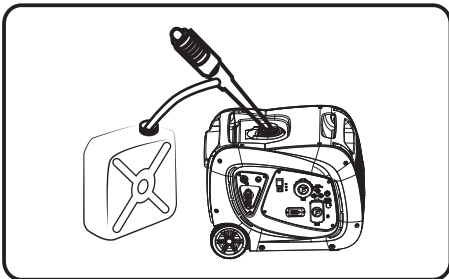

⚠ DANGER

Drain fuel into approved container outdoors, away from open flame. Be sure engine is cool. Do not smoke.

4-FUEL STARVATION: Start and run the generator until stops from lack of fuel. This will dry out all remained fuel in tank, fuel lines and carburetor.

5-Allow the unit to cool entirely before cleaning and storage.

6-Change oil with recommended grade oil.

7-Remove spark plug and pour about one teaspoon of engine oil through the spark plug hole, pull the recoil starter several times to distribute the oil for lubricating the cylinder. Reattach the spark plug. Pull recoil slowly until resistance is felt. This will close valves so moisture cannot enter engine cylinder. Gently release recoil starter.

8-Keep the engine switch and fuel valve on "OFF" position.

9-Cover the unit and store in a clean, dry place out of direct sunlight. **NEVER USE WATER TO CLEAN GENERATOR.**

NOTE:

- We recommend always using a fuel stabilizer. **A FUEL STABILIZER** will minimize the formulation of fuel gum deposits during storage, the fuel stabilizer can be added to the gasoline in the fuel tank, or into the gasoline in a storage container.
- If it is not practical to empty the fuel tank and the unit is to be stored for some time, use a commercially available **FUEL STABILIZER** added to the gasoline to increase the life of the gasoline. Run the unit for 5-10 minutes, turn off the fuel valve and allow to run until engine stops from lack of fuel (**FUEL STARVATION**).
- Any damages or hazards caused by using improper fuel, improperly stored fuel, and/or improperly formulated stabilizers, are not covered by manufacturer's warranty.
- Do not store gasoline from one season to another season.

TROUBLE SHOOTING

Problem	Cause	Correction
Engine is running, but no AC output is available.	<ol style="list-style-type: none"> 1. Circuit breaker is open. 2. Fault in generator. 3. Poor connection or defective cord set. 4. Connected device is bad. 	<ol style="list-style-type: none"> 1. Reset circuit breaker. 2. Contact authorized service facility. 3. Check and repair. 4. Connect another device that is in good condition.
Engine runs good at no-load but "bogs down" when loads are connected.	<ol style="list-style-type: none"> 1. Short circuit in a connected load. 2. Engine speed is too slow. 3. Generator is overloaded. 4. Shorted generator circuit. 5. Clogged or dirty fuel filter. 	<ol style="list-style-type: none"> 1. Disconnect shorted electrical load. 2. Contact authorized service facility. 3. See Don't Overload Generator 4. Contact authorized service facility. 5. Clean or replace fuel filter.
Engine will not start; starts and runs rough or shuts down when running.	<ol style="list-style-type: none"> 1. Engine switch set to OFF (O) position. 2. Fuel shutoff lever is in OFF (O) position. 3. Low oil level. 4. Dirty air cleaner. 5. Out of fuel. 6. Stale fuel. 7. Spark plug wire not connected to spark plug. 8. Bad spark plug. 9. Water in fuel. 10. Flooded. 11. Excessively rich fuel mixture. 12. Intake valve stuck open or closed. 13. Engine has lost compression. 14. Clogged or dirty fuel filter. 	<ol style="list-style-type: none"> 1. Set engine switch to ON (I) position. 2. Move fuel shutoff lever to ON (I) position. 3. Fill crankcase to proper level or place generator on level surface. 4. Clean or replace air cleaner. 5. Fill fuel tank. 6. Drain fuel tank and carburetor; fill with fresh fuel. 7. Connect wire to spark plug. 8. Replace spark plug. 9. Drain gas tank and carburetor; fill with fresh fuel. 10. Wait 5 minutes and re-crank engine. 11. Contact authorized service facility. 12. Contact authorized service facility. 13. Contact authorized service facility. 14. Clean or replace fuel filter.
Engine lacks power.	<ol style="list-style-type: none"> 1. Load is too high. 2. Dirty air filter. 3. Clogged or dirty fuel filter. 4. Clogged spark arrester. 	<ol style="list-style-type: none"> 1. Don't Overload Generator 2. Replace air filter. 3. Clean or replace fuel filter. 4. Clean or replace spark arrester.
Engine "hunts" or falters.	<ol style="list-style-type: none"> 1. Carburetor is running too rich or too lean. 2. Clogged or dirty fuel filter. 	<ol style="list-style-type: none"> 1. Contact authorized service facility. 2. Clean or replace fuel filter.
Engine shuts down when running.	<ol style="list-style-type: none"> 1. Out of fuel. 2. Dirty air cleaner. 3. Low oil level. 	<ol style="list-style-type: none"> 1. Fill fuel tank. 2. Clean or replace air cleaner. 3. Fill crankcase to proper level or place generator on level surface.

PARTS DIAGRAM AND PARTS LIST

W03083 Parts Diagram

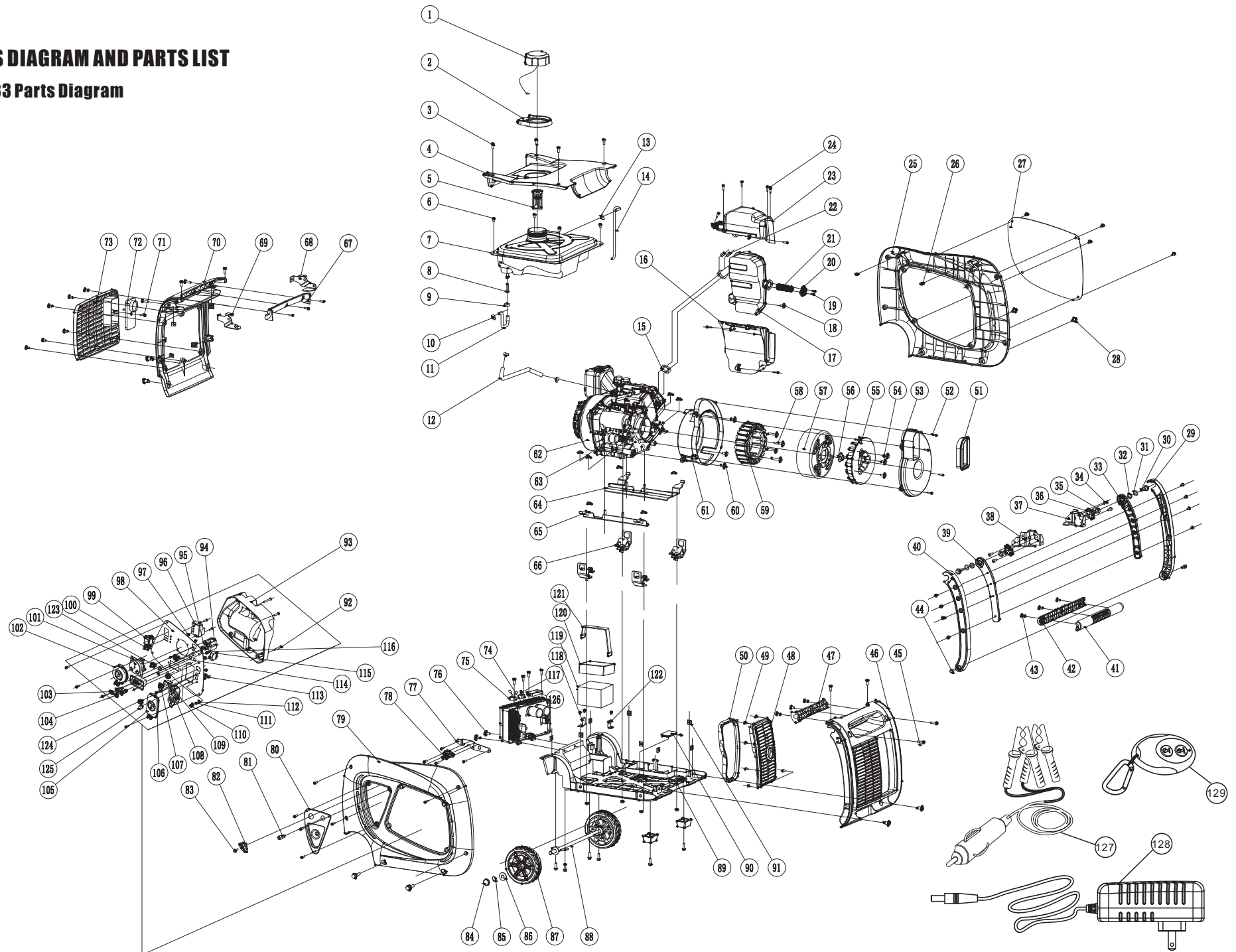

171cc Engine Parts Diagram

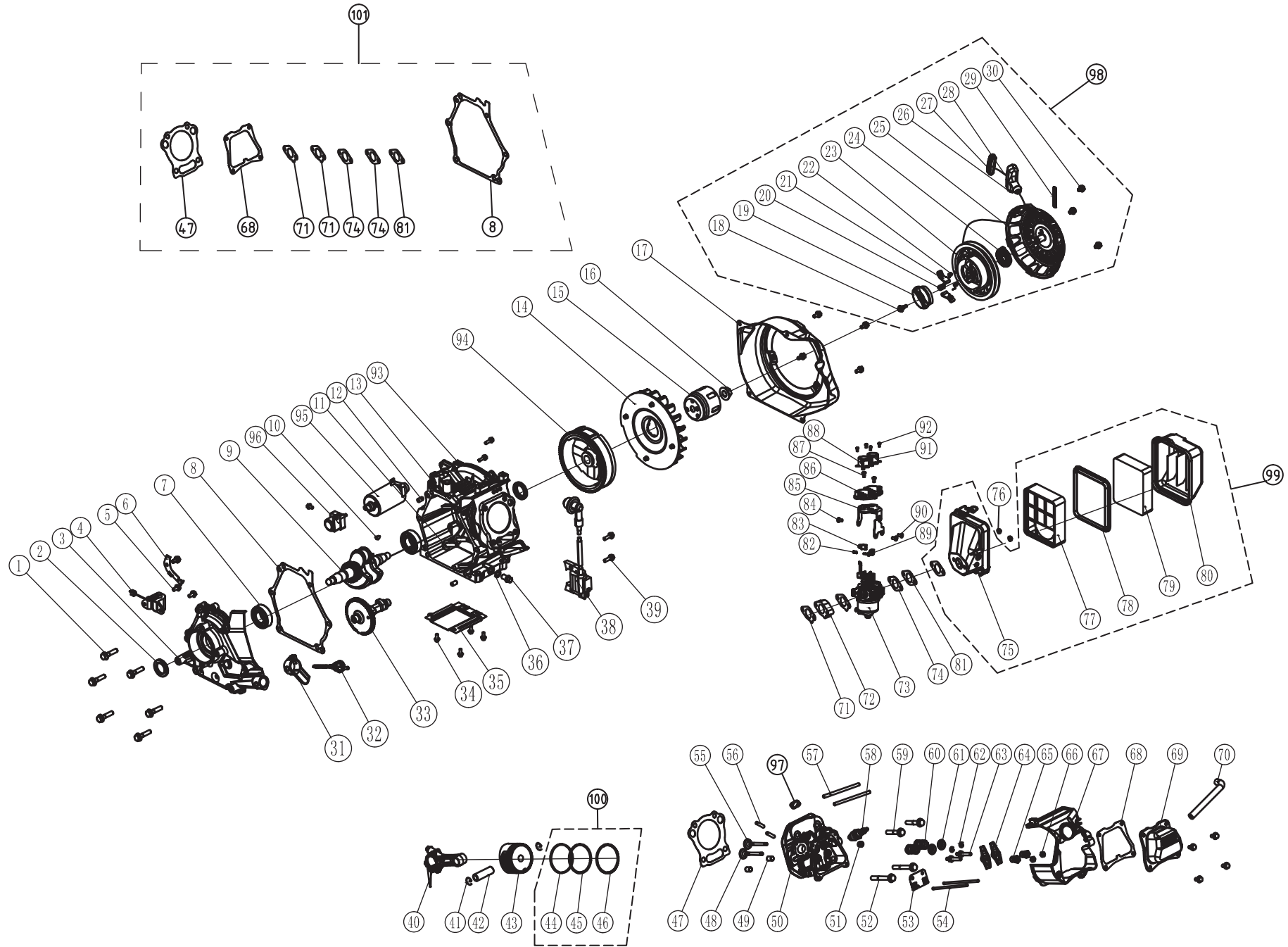

W03083 Parts List

NO.	Part Number	Description	Qty.	NO.	Part Number	Description	Qty.
1	330713500	Fuel Tank Cap	1	66	330713565	Motor Mount	4
2	330713501	Spillway,Fuel Tank	1	67	330713566	Fixed Handle,Left	1
3	330713502	Screw M5×20	6	68	330713567	Supporter,Handle Left(Engine)	1
4	330713503	Cover,top	1	69	330713568	Supporter,Handle Right(Engine)	1
5	330713504	Fuel Filter Assembly	1	70	330713569	Cover,Left Side	1
6	330713505	Screw M6×12	4	71	330713570	Screw ST4.8×13	1
7	330713506	Fuel Tank	1	72	330713571	Cover Plate,Left	1
8	330713507	Inline Fuel Filter Assembly	1	73	330713572	Air Cleaner Cover	1
9	330713508	Clamp(Ø10.5×8)	1	74	330713573	Control Unit Module	1
10	330713509	Clamp(Ø 8.7×8)	3	75	330713574	Rectifier	1
11	330713510	Fuel Hose 1	1	76	330713575	Flange Bolt M6×25	1
12	330713511	Fuel Hose 2	1	77	330713626	Stents,Fuel Valve	1
13	330713512	Clamp(Ø8×6)	1	78	330713577	Fuel Valve Bracket	1
14	330713513	Fuel Hose 3	1	79	330713634	Front Cover	1
15	330713514	Gasket,Exhaust	1	80	330713627	Guide,Rope	1
16	330713515	Muffler Protector Assembly,Lower	1	81	330713628	Button,Choke Assy.	1
17	330713516	Muffler Assembly	1	82	330713581	Fuel Valve Knob	1
18	330713517	Flange Bolt M6×12	5	83	330713582	Screw/Washer Assembly M4×14	3
19	330713518	Screw/Washer Assembly M5×14	2	84	330713583	Cap,Wheel	2
20	330713519	Cover,Spark Arrester	1	85	330713584	Retaining Ring Ø12	2
21	330713520	Spark Arrester	1	86	330713585	Washer Ø12	2
22	330713521	Nut M6	1	87	330713586	Wheel	2
23	330713522	Muffler Protector Assembly,Upper	1	88	330713587	Axle	2
24	330713523	Screw ST4.2×16	6	89	330713588	Base Assy.	1
25	330713524	Supporter,Maintenance Cover	1	90	330713589	Rubber Plug	1
26	330713525	Cage Nut M5	12	91	330713590	Lock Nut M6	8
27	330713526	Maintenance Cover	1	92	330713591	Screw/Washer Assembly M5×38	2
28	330713527	Bolt M6×16	8	93	330713592	Control Box	1
29	330713528	Handle,Right	1	94	330713593	Receptacle USB	1
30	330713529	Bolt M8×16	2	95	330713594	20A Breaker,Push Button	1
31	330713530	Washer(Ø13×Ø20×2.5)	2	96	330713595	LED Indicator Assy.	1
32	330713531	Bushing(Ø13.3×Ø19.3×2)	2	97	330713596	Nut M4	8
33	330713532	Handle Bracket,Right	1	98	330713597	Control Panel	1
34	330713533	Bolt M6×12	4	99	330713617	Ignition Switch	1
35	330713534	Bushing(Ø13.3×Ø19.3×8)	2	100	330713599	Switch,Economy(ECO)	1
36	330713535	Pivot Bracket	2	101	330713600	Receptacle TT-30R	1
37	330713536	Supporter,Right	1	102	330713601	Receptacle Cover, TT-30R	1
38	330713537	Supporter,Left	1	103	330713602	Parallel Cover	2
39	330713538	Handle Bracket,Left	1	104	330713603	Parallel Outlets	2
40	330713539	Handle,Left	1	105	330713604	Receptacle Cover,5-20R Duplex	1
41	330713540	Handle,Upper	1	106	330713605	Screw/Washer Assembly M3×10	3
42	330713541	Handle,Lower	1	107	330713606	Receptacle Cover,DC 12V	1
43	330713542	Screw M5×14	41	108	330713607	Receptacle 5-20R Duplex	1
44	330713543	Flange Bolt M6×35	2	109	330713608	Receptacle DC 12V	1
45	330713544	Screw M6×20	4	110	330713609	Nut M5	1
46	330713545	Cover,Right Side	1	111	330713610	Nut M5	1
47	330713546	Fixed Handle,Right	1	112	330713611	Washer Ø5	2
48	330713547	Muffler Cover	1	113	330713612	Bolt M5×16	1
49	330713548	Screw ST3.5×9.5	6	114	330713613	Receptacle Cover, USB	1
50	330713549	Rubber Seal Sleeve	1	115	330713614	D.C 10A Breaker,Push Button	1
51	330713550	Rubber Sleeve,End Cover	1	116	330713618	Receptacle (Battery Charger)	1
52	330713551	Screw ST4.8×16	1	117	330713619	Charger	1
53	330713552	Generator End Cover	1	118	330713620	Support 1,Battery	1
54	330713553	Flange Bolt M6×15	3	119	330713621	Battery(5.5AH)	1
55	330713554	Generator Fan	1	120	330713622	Sheath,Battery	1
56	330713555	Nut M14	1	121	330713623	Rubber Belt	1
57	330713615	Rotor Assembly	1	122	330713624	Support 2,Battery	1
58	330713557	Flange Bolt M6×45	4	123	330713629	Battery Power Restore Switch	1
59	330713558	Stator Assembly	1	124	330713630	Remote Indicator Light	1
60	330713559	Flange Bolt M6×20	6	125	330713631	Program Button	1
61	330713560	Generator End Cover	1	126	330713632	Remote Module	1
62	330713625	Engine	1	127	330713633	Battery Charge Cable	1
63	330713562	Flange Lock Nut M8	12	128	330713634	12V DC Battery Charger	1
64	330713563	Supporter,Left	1	129	336713641	Remote Control	1
65	330713564	Supporter,Right	1				

SPE175ER 171cc Engine Parts List

NO.	Part Number	Description	Qty.
1	330723500	Flange Bolt M8×35	6
2	330723501	Oil Seal	2
3	330723502	Cover,crankcase	1
4	330723503	Oil Level Sensor	1
5	330723504	Flange BOLT M6×12	12
6	330723505	Plate, Coil	1
7	330723506	Bearing 6205	2
8	330723507	Gasket,Crankcase Cover	1
9	330723508	Crankshaft	1
10	330723509	Woodruff key(4×6.5×16)	1
11	330723510	Lifter,Valve	2
12	330723511	Locating Pins	2
13	330723512	Seal Strip,Crankcase COVER	2
14	330723513	Cooling Fan	1
15	330723514	Pulley,Starter	1
16	330723515	Nut M14	1
17	330723516	Fan cover	1
18	330723517	Screw,Pawl Guide	1
19	330723518	Pawl Guide	1
20	330723519	Spring,Ratchet Guide	1
21	330723520	Patchet,Starter	2
22	330723521	Spring,Ratchet	2
23	330723522	Reciol Starter Reel	1
24	330723523	Reciol Starter Spring	1
25	330723524	Reciol Starter Cover	1
26	330723525	Grip ,Starter	1
27	330723526	Rope Button	1
28	330723527	Rope (φ5×1550)	1
29	330723528	Wire Clip	1
30	330723529	Flange Bolt M6×8	3
31	330723530	Oil Nipple	1
32	330723531	Oil Dipstick Assembly	1
33	330723532	Camshafe Comp	1
34	330723533	SCREWWasher Assembly M5×10	1
35	330723534	Air Guide Board	1
36	330723535	Washer,Drain Bolt	1
37	330723536	Bolt, Drain	1
38	330723537	Ignition Coil	1
39	330723538	Flange Bolt M6×20	4
40	330723539	Connecting Rod	1
41	330723540	Circlip	2
42	330723541	Piston Pin	1
43	330723542	Piston	1
44	330723543	Ring Coil	1
45	330723544	Ring ,Second Piston	1
46	330723545	Ring ,First Piston	1
47	330723546	Gasket, Cylinder Head	1
48	330723547	Valve,Exhaust	1
49	330723548	Locating Pins	2
50	330723549	Cylinder Head	1
51	330723550	Oil Seal,Valve	1
52	330723551	Flange Bolt M8×65	2

NO.	Part Number	Description	Qty.
53	330723552	Guide Plate,Push Rod	1
54	330723553	Push Rod	2
55	330723554	Valve,Intake	1
56	330723555	Stud Bolt(M6×32)	2
57	330723556	Stud Bolt(M6×97)	2
58	330723557	Spark Plug(F6RTC)	1
59	330723558	Flange Bolt M8×45	2
60	330723559	Spring,Valve	2
61	330723560	Retainer,Valve Spring	2
62	330723561	Valve Collet	2
63	330723562	Bolt,Rocker Arm	2
64	330723563	Rocker Arm ,Valve	2
65	330723564	Adjusting Nut,Valve	2
66	330723565	Lock Nut	2
67	330723566	Air Shroud,Cylinder	1
68	330723567	Gasket,Cylinder Head Cover	1
69	330723568	Cylinder Head Cover Assembly	1
70	330723569	Breather Tube	1
71	330723570	Gasket,Insulator	2
72	330723571	Insulator,Carburetor	1
73	330723572	Carburetor,Assembly	1
74	330723573	Gasket, Air Cleaner	2
75	330723574	Base,Air Cleaner	1
76	330723575	Nut M6	2
77	330723576	Clapboard	1
78	330723577	Sealing Ring	1
79	330723578	Element,Air Cleaner	1
80	330723579	Cover,Air Cleaner	1
81	330723580	Flange	1
82	330723581	Spring,Connector	2
83	330723582	Connector,Throttle Valve Axis	1
84	330723583	SCREWWasher Assembly M5×10	2
85	330723600	Support,Stepper Motor	1
86	330723601	Stepper Motor Base	1
87	330723588	SCREWWasher Assembly M4×8	2
88	336723603	Stepper Motor ,Choke Valve	1
89	330723602	Connector,Choke Valve Axis	1
90	330723582	Screw M5×10	1
91	330723589	Stepper Motor ,Throttle Valve	1
92	330723590	Screw M3×6	4
93	330723594	Crankcase	1
94	330723595	Flywheel	1
95	330723596	Starter Motor	1
96	330723597	Relay,Starter	1
97	330713514	Gasket,Exhaust	1
98	330423500	Recoil Starter Set	1
99	330423501	Air Cleaner Set	1
100	330423502	Piston Rings Set	1
101	330423504	Gasket Set	1

SERVICE INFORMATION

CONTACT THE FIRMAN PRODUCT SERVICE DEPARTMENT AT 1-844-347-6261

or at www.firmangenerators.com
to obtain warranty service
information or to order
replacement parts or
accessories.

HOW TO ORDER REPLACEMENT PARTS

Even quality built equipment such as the electric generator you have purchased might need occasional replacement parts to maintain it in good condition over the years. To order replacement parts, please give the following information:

1. Model No. ,Rev. Level and Serial No. and all specifications shown on the Model No./Serial No. plate.
2. Parts number or numbers as shown in the Parts List section.
3. A brief description of the trouble with the generator.

REGISTER YOUR PRODUCT

Register your Firman generator online at www.firmangenerators.com

WARRANTY

FIRMAN Three (3) Year Limited Warranty

Warranty Qualifications

FIRMAN GENERATOR will register the warranty upon receipt of your Warranty Registration Card and a copy of your sales receipt from one of FIRMAN's retail locations as proof of purchase. Please submit your warranty registration and your proof of purchase within ten (10) days of the date of purchase.

Repair/Replacement Warranty

FIRMAN warrants to the original purchaser that the mechanical and electrical components will be free of defects in material and workmanship for a period of one (1) year (parts and labor) and three (3) years (parts) from the original date of purchase 90 days [parts and labor] and 180 days [parts] for commercial & industrial use. Transportation charges on product submitted for repair or replacement under this warranty are the sole responsibility of the purchaser. This warranty only applies to the original purchaser and is not transferable.

Do Not Return the Unit to the Place of Purchase

Contact the FIRMAN Service Center and FIRMAN will troubleshoot any issue via phone or e-mail. If the problem is not corrected by this method, FIRMAN will, at its option, authorize evaluation, repair or replacement of the defective part or component at a FIRMAN Service Center. FIRMAN will provide you with a case number for warranty service. Please keep it for future reference. Repairs or replacements without prior authorization, or at an unauthorized repair facility, will not be covered by this warranty.

Warranty Exclusions

This warranty does not cover the following repairs and equipment:

Normal Wear

Your product needs periodic parts and service to perform well. This warranty does not cover repair when normal use has exhausted the life of a part or the equipment as a whole.

Installation, Use and Maintenance

This warranty will not apply to parts and/or labor if your product is deemed to have been misused, neglected, involved in an accident, abused, loaded beyond the generator's limits, modified, installed improperly or connected incorrectly to any electrical component.

Normal maintenance is not covered by this warranty.

Other Exclusions

This warranty excludes:

- cosmetic defects such as paint, decals, etc.
- wear items
- accessory parts
- failures due to acts of God and other force majeure events beyond the manufacturer's control
- problems caused by parts that are not original FIRMAN parts

Limits of Implied Warranty and Consequential Damage

FIRMAN disclaims any obligation to cover any loss of time, use of this product, freight, or any incidental or consequential claim by anyone from using this product. THIS WARRANTY IS IN LIEU OF ALL OTHER WARRANTIES, EXPRESS OR IMPLIED, INCLUDING WARRANTIES OF MERCHANTABILITY OR FITNESS FOR A PARTICULAR PURPOSE.

A unit provided as an exchange will be subject to the warranty of the original unit. The length of the warranty governing the exchanged unit will remain calculated by reference to the purchase date of the original unit.

This warranty gives you certain legal rights which may change from state to state. Your state may also have other rights you may be entitled to that are not listed within this warranty.

Contact Information

You may contact FIRMAN at:

Address

Firman Power Equipment
Attn: Customer Service
14131 N Rio Vista Blvd, Suite 9
Peoria, AZ 85381
www.firmangenerators.com

*We are FIRMAN POWER - And we are here for you.
Customer Service Desk - 1-844-347-6261(1-844-FIRMAN1)
6am PST(9am EST) until 8pm EST(5pm PST)
Technical Service Desk - 1-844-347-6261(1-844-FIRMAN1)
6am PST(9am EST) until 8pm EST(5pm PST)
24/7 Tech Support - 1-844-347-6261(1-844-FIRMAN1)*

FIRMAN POWER EQUIPMENT INC.

Emission Control System Warranty

CALIFORNIA AND FEDERAL EXHAUST AND EVAPORATIVE EMISSIONS CONTROL WARRANTY STATEMENT GASOLINE ENGINES

YOUR WARRANTY RIGHTS AND OBLIGATIONS

The California Air Resources Board, US Environmental Protection Agency ("US EPA") and FIRMAN POWER EQUIPMENT INC. (FIRMAN) are pleased to explain the exhaust and evaporative emissions control systems warranty on your 2016-2017 or later Small Off-Road Engine ("SORE") and engine powered equipment as applicable. In California and the USA, SORE and engine powered equipment must be designed, built and equipped to meet California as applicable. In California and the USA, SORE and engine powered equipment must be designed, built and equipped to meet California and US EPA stringent anti-smog standards. FIRMAN must warrant the emissions control systems on your SORE and engine powered equipment for the period listed below provided there has been no abuse, neglect or improper maintenance of your SORE or engine powered equipment. Your exhaust emission control systems may include parts such as carburetors, fuel-injection systems, the ignition system, and catalytic converters. Also included may be an evaporative emission control system which may include fuel tanks, fuel lines, fuel caps, valves, canisters, filters, vapor hoses, clamps, connectors, belts and other associated components. For engines less than or equal to 80 cc, only the fuel tank is subject to the evaporative emission control warranty requirements of this section (California only).

OWNER'S WARRANTY RESPONSIBILITIES:

As the SORE or engine powered equipment owner, you are responsible for the performance of the required maintenance listed in your owner's manual. FIRMAN recommends that you retain all receipts covering maintenance on your SORE or engine powered equipment, but FIRMAN cannot deny warranty solely for the lack of receipts.

As the SORE or engine powered equipment owner, you should however be aware that FIRMAN may deny you warranty coverage if your SORE or engine powered equipment or a part has failed due to abuse, neglect, improper maintenance or unapproved modifications.

You are responsible for presenting your SORE or engine powered equipment to a FIRMAN distribution or service center as soon as a problem exists. The warranty repairs should be completed in a reasonable amount of time, not to exceed 30 days. If you have a question regarding your warranty coverage, you should contact FIRMAN at 1-844-347-6261 or firmangenerators@sumec-na.com.

GENERAL EMISSIONS WARRANTY COVERAGE

This emission control system is warranted for three years. The warranty period begins on the date the engine or equipment is delivered to an ultimate purchaser. FIRMAN warrants to the ultimate purchaser and each subsequent purchaser that the engine is:

Designed, built, and equipped so as to conform with all applicable regulations adopted by the Air Resources Board and US EPA; and Free from defects in materials and workmanship that cause the failure of a warranted part to be identical in all material respects to the part as described in the engine manufacturers application for certification.

The warranty on emissions-related parts is as follows:

- (1) Any warranted part that is not scheduled for replacement as required maintenance in the owner's manual supplied, is warranted for the warranty period stated above. If any such part fails during the period of warranty coverage, the part will be repaired or replaced by FIRMAN at no charge to the owner. Any such part repaired or replaced under the warranty will be warranted for the remaining warranty period.
- (2) Any warranted part that is scheduled only for regular inspection in the owner's manual supplied, is warranted for the warranty period stated above. Any such part repaired or replaced under warranty will be warranted for the remaining warranty period.
- (3) Any warranted part that is scheduled for replacement as required maintenance in the owner's manual supplied, is warranted for the period of time prior to the first scheduled replacement point for that part. If the part fails prior to the first scheduled replacement, the part will be repaired or replaced by FIRMAN at no charge to the owner. Any such part repaired or replaced under warranty will be warranted for the remainder of the period prior to the first scheduled replacement point for the part.
- (4) Repair or replacement of any warranted part under the warranty must be performed at no charge to the owner at a warranty station.
- (5) Notwithstanding the provisions of Subsection (4) above, warranty services or repairs must be provided by FIRMAN that are franchised to service the subject engines.
- (6) The owner must not be charged for diagnostic labor that leads to the determination that a warranted part is in fact defective, provided that such diagnostic work is performed at a warranty station.
- (7) FIRMAN is liable for damages to other engine components proximately caused by a failure under warranty of any warranted part.
- (8) Throughout the emissions warranty period defined in Subsection (b)(2), FIRMAN will maintain a supply of warranted parts sufficient to meet the expected demand for such parts.
- (9) Any replacement part may be used in the performance of any warranty maintenance or repairs and must be provided without charge to the owner. Such use will not reduce the warranty obligations of the manufacturer.
- (10) Add-on or modified parts that are not exempted by the Air Resources Board may not be used. The use of any non-exempted add-on or modified parts by the ultimate purchaser will be grounds for disallowing a warranty claim.

The manufacturer will not be liable to warrant failures of warranted parts caused by the use of a non-exempted add-on or modified part.

PARTS COVERED BY WARRANTY

Listed below are the parts (if equipped) covered by the Federal and California Emission Control Systems Warranty. Some parts listed below may require scheduled maintenance and are warranted up to the first scheduled replacement point for that part.

1. Ignition system including: - Spark plug - Ignition coil	4. Air induction system including: - Intake pipe/manifold - Air cleaner
2. Fuel metering system: - Fuel tank - Fuel cap - Fuel line and related fittings/clamps - Carburetor assembly including internal parts and gaskets	5. Crankcase breather assembly including: - Breather connection tube
3. Catalytic muffler assembly including: - Exhaust manifold - Catalytic converter - Muffler gasket - pulse valve	6. Fuel tank evaporative emission control system including: - Purge valves - Carbon canister - Vapor hoses and fitting/clamps

Limitations

This Emission Control Systems Warranty shall not cover any of the following:

- (a) Consequential damages such as loss of time, inconvenience, loss of use of the engine or equipment, etc.
- (b) Diagnosis and inspection fees that do not result in eligible warranty service being performed.

FIRMAN POWER EQUIPMENT INC.

Email: firmangenerators@sumec-na.com

www.firmangenerators.com

Firman Power Equipment Inc.

14131 N Rio Vista Blvd, Suite 9

Peoria, AZ 85381

www.firmangenerators.com